

ETSI EN 302 208 V3.1.1 (2016-11)

Radio Frequency Identification Equipment operating in the band 865 MHz to 868 MHz with power levels up to 2 W and in the band 915 MHz to 921 MHz with power levels up to 4 W; Harmonised Standard covering the essential requirements of article 3.2 of the Directive 2014/53/EU

Reference

REN/ERM-TG34-264

Keywords

harmonised standard, ID, radio, RFID, SRD

ETSI

650 Route des Lucioles
F-06921 Sophia Antipolis Cedex - FRANCE

Tel.: +33 4 92 94 42 00 Fax: +33 4 93 65 47 16

Siret N° 348 623 562 00017 - NAF 742 C
Association à but non lucratif enregistrée à la
Sous-Préfecture de Grasse (06) N° 7803/88

Important notice

The present document can be downloaded from:
<http://www.etsi.org/standards-search>

The present document may be made available in electronic versions and/or in print. The content of any electronic and/or print versions of the present document shall not be modified without the prior written authorization of ETSI. In case of any existing or perceived difference in contents between such versions and/or in print, the only prevailing document is the print of the Portable Document Format (PDF) version kept on a specific network drive within ETSI Secretariat.

Users of the present document should be aware that the document may be subject to revision or change of status. Information on the current status of this and other ETSI documents is available at
<https://portal.etsi.org/TB/ETSIDeliverableStatus.aspx>

If you find errors in the present document, please send your comment to one of the following services:
<https://portal.etsi.org/People/CommiteeSupportStaff.aspx>

Copyright Notification

No part may be reproduced or utilized in any form or by any means, electronic or mechanical, including photocopying and microfilm except as authorized by written permission of ETSI.

The content of the PDF version shall not be modified without the written authorization of ETSI.

The copyright and the foregoing restriction extend to reproduction in all media.

© European Telecommunications Standards Institute 2016.
All rights reserved.

DECT™, **PLUGTESTS™**, **UMTS™** and the ETSI logo are Trade Marks of ETSI registered for the benefit of its Members.
3GPP™ and **LTE™** are Trade Marks of ETSI registered for the benefit of its Members and of the 3GPP Organizational Partners.
GSM® and the GSM logo are Trade Marks registered and owned by the GSM Association.

Contents

Intellectual Property Rights	7
Foreword.....	7
Modal verbs terminology.....	7
1 Scope	8
2 References	9
2.1 Normative references	9
2.2 Informative references.....	9
3 Definitions, symbols and abbreviations	10
3.1 Definitions	10
3.2 Symbols.....	11
3.3 Abbreviations	11
4 Technical requirements specifications	12
4.1 Environmental profile.....	12
4.2 General requirements	12
4.2.1 Conformance requirements	12
4.2.2 Designated frequencies	13
4.2.2.1 Lower band	13
4.2.2.2 Upper band.....	13
4.2.3 Testing of operational frequencies.....	14
4.2.4 General considerations.....	14
4.2.5 Choice of samples for test suite	15
4.3 Transmitter conformance requirements.....	15
4.3.1 Frequency error.....	15
4.3.1.1 Applicability.....	15
4.3.1.2 Definition	15
4.3.1.3 Limits	15
4.3.1.4 Conformance.....	15
4.3.2 Frequency stability under low voltage conditions	15
4.3.2.1 Applicability.....	15
4.3.2.2 Definition	15
4.3.2.3 Limits	16
4.3.2.4 Conformance.....	16
4.3.3 Effective radiated power	16
4.3.3.1 Applicability.....	16
4.3.3.2 Definition	16
4.3.3.3 Limits	16
4.3.3.3.1 Operation in the lower band (865 MHz to 868 MHz)	16
4.3.3.3.2 Operation in the upper band (915 MHz to 928 MHz)	16
4.3.3.4 Conformance.....	16
4.3.4 Transmitter antenna beam-width	16
4.3.4.1 Applicability.....	16
4.3.4.2 Definition	16
4.3.4.3 Limits	17
4.3.4.4 Conformance.....	17
4.3.5 Transmitter spectrum masks	17
4.3.5.1 Applicability.....	17
4.3.5.2 Definition	17
4.3.5.3 Limits	17
4.3.5.3.1 Limits for lower band (865 MHz to 868 MHz)	17
4.3.5.3.2 Limits for upper band (915 MHz to 921 MHz)	18
4.3.5.4 Conformance.....	19
4.3.6 Transmitter spurious emissions.....	19
4.3.6.1 Applicability.....	19
4.3.6.2 Definition	19

4.3.6.3	Limits	19
4.3.6.4	Conformance	20
4.3.7	Transmission times	20
4.3.7.1	Applicability.....	20
4.3.7.2	Definition	20
4.3.7.3	Limits	20
4.3.7.4	Conformance.....	20
4.3.8	Mitigation using DAA	21
4.3.8.1	Applicability.....	21
4.3.8.2	Definition	21
4.3.8.3	Limits	21
4.3.8.4	Conformance	21
4.4	Receiver conformance requirements	21
4.4.1	Adjacent channel selectivity	21
4.4.1.1	Applicability.....	21
4.4.1.2	Definition	21
4.4.1.3	Limits	21
4.4.1.4	Conformance.....	21
4.4.2	Blocking or desensitization.....	22
4.4.2.1	Applicability.....	22
4.4.2.2	Definition	22
4.4.2.3	Limits	22
4.4.2.4	Conformance	22
4.4.3	Spurious emissions	22
4.4.3.1	Applicability.....	22
4.4.3.2	Definition	22
4.4.3.3	Limits	22
4.4.3.4	Conformance.....	22
4.5	Tag conformance requirements	23
4.5.1	Radiated power (e.r.p.)	23
4.5.1.1	Applicability.....	23
4.5.1.2	Definition	23
4.5.1.3	Limits	23
4.5.1.4	Conformance	23
4.5.2	Unwanted emissions	23
4.5.2.1	Applicability.....	23
4.5.2.2	Definition	23
4.5.2.3	Limits	23
4.5.2.4	Conformance	24
5	Testing for compliance with technical requirements.....	25
5.1	Environmental conditions for testing	25
5.1.1	Normal and extreme test conditions.....	25
5.1.1.1	Normal test conditions	25
5.1.1.2	Extreme temperatures.....	25
5.1.1.2.1	Procedure for tests at extreme temperatures	25
5.1.1.2.2	Procedure for equipment designed for continuous operation	25
5.1.1.2.3	Procedure for equipment designed for intermittent operation	25
5.1.1.3	Extreme temperature ranges.....	26
5.1.2	Test power sources.....	26
5.1.2.1	General requirements	26
5.1.2.2	Normal test power source.....	26
5.1.2.2.1	Mains voltage	26
5.1.2.2.2	Regulated lead-acid battery power sources	26
5.1.2.2.3	Other power sources	26
5.1.2.3	Extreme test power source	27
5.1.2.3.1	Mains voltage	27
5.1.2.3.2	Regulated lead-acid battery power sources and gel-cell battery power sources	27
5.1.2.3.3	Power sources using other types of batteries	27
5.1.2.3.4	Other power sources	27
5.1.3	Testing under extreme conditions.....	27
5.2	Interpretation of the measurement results	27

5.3	Submission of equipment for testing	28
5.3.1	Mechanical and electrical design	28
5.3.1.1	General requirements	28
5.3.1.2	Controls	28
5.3.1.3	Transmitter shut-off facility	28
5.3.1.4	Battery saving circuit	28
5.3.1.5	Declarations by the provider	28
5.3.1.6	Auxiliary test equipment	28
5.3.2	General conditions for testing of transmitters	29
5.3.2.1	Normal test signals and test modulation	29
5.3.2.2	Normal test signals for data	29
5.3.2.3	Artificial antenna	29
5.3.2.4	Modes of operation of the transmitter	29
5.3.2.5	Test sites and general arrangements for radiated measurements	29
5.3.2.6	Measuring receiver	29
5.3.2.7	Testing of operational frequencies	29
5.4	Presentation of equipment for testing	29
5.4.1	General requirements	29
5.4.2	Choice of model for testing	30
5.4.3	Provisions of samples for testing	30
5.4.4	Equipment without an internal permanent or temporary antenna connector	30
5.4.5	Test fixture	30
5.4.6	Submission of additional equipment with a temporary antenna connector	31
5.4.7	Channel range	31
5.4.8	Adjustable carrier levels	31
5.4.9	Test mode	31
5.5	Essential transmitter test suites	32
5.5.1	Measurement of frequency error for mains operated equipment	32
5.5.2	Frequency stability under low voltage conditions	32
5.5.3	Effective Radiated power (e.r.p.)	32
5.5.3.1	General	32
5.5.3.2	Method of measurement	32
5.5.3.2.1	General	32
5.5.3.2.2	Radiated measurement	32
5.5.3.2.3	Conducted measurement	34
5.5.4	Transmitter antenna beam-width	34
5.5.4.1	General	34
5.5.4.2	Radiated measurement	34
5.5.5	Transmitter spectrum mask	35
5.5.5.1	Method of measurement	35
5.5.6	Transmitter spurious emissions	36
5.5.6.1	Method of measurement	36
5.5.6.2	Method of measuring the spurious power level in a specified load, clause 5.5.6.1, a) i)	37
5.5.6.3	Method of measuring the spurious effective radiated power, clause 5.5.6.1 a) ii)	37
5.5.6.4	Method of measuring spurious effective radiated power, clause 5.5.6.1, b)	38
5.5.7	Transmission times	39
5.5.7.1	Method of measurement	39
5.5.8	Mitigation using DAA	39
5.5.8.1	Set-up for tests	39
5.5.8.2	Tests for Mitigation Method 1	40
5.5.8.3	Tests for Mitigation Method 2	41
5.6	Essential receiver test suites	43
5.6.1	Adjacent channel selectivity	43
5.6.1.1	General	43
5.6.1.2	Method of measuring radiated signals	43
5.6.1.3	Conducted method of measurement	44
5.6.2	Blocking or desensitization	46
5.6.2.1	General	46
5.6.2.2	Method of measuring radiated signals	46
5.6.2.3	Conducted method of measurement	47
5.7	Essential tag test suites	47
5.7.1	Tag radiated power (e.r.p.)	47

5.7.1.1	Method of measurement.....	47
5.7.1.2	Method of measuring the power in an un-modulated sub-carrier, clause 5.7.1.1 a).....	48
5.7.1.3	Method of measuring the power in a modulated sub-carrier, clause 5.7.1.1 b).....	49
5.7.2	Unwanted emissions	50
5.7.2.1	Method of measurement.....	50
Annex A (normative):	Relationship between the present document and the essential requirements of Directive 2014/53/EU	52
Annex B (normative):	Radiated measurement.....	54
B.1	Test sites and general arrangements for measurements involving the use of radiated fields	54
B.1.1	General	54
B.1.2	Anechoic chamber	54
B.1.3	Anechoic chamber with a conductive ground plane	55
B.1.4	Open Area Test Site (OATS)	56
B.1.5	Test antenna.....	57
B.1.6	Substitution antenna	57
B.1.7	Measuring antenna	58
B.1.8	Stripline arrangement	58
B.1.8.1	General.....	58
B.1.8.2	Description.....	58
B.1.8.3	Calibration	58
B.1.8.4	Mode of use	58
B.2	Guidance on the use of radiation test sites	58
B.2.1	General	58
B.2.2	Verification of the test site	59
B.2.3	Preparation of the EUT.....	59
B.2.4	Power supplies to the EUT	59
B.2.5	Range length.....	59
B.2.6	Site preparation	60
B.3	Coupling of signals.....	60
B.3.1	General	60
B.3.2	Data signals	60
B.4	Standard test position	61
B.5	Test fixture	61
B.5.1	General	61
B.5.2	Description	61
B.5.3	Calibration.....	62
B.5.4	Mode of use.....	63
Annex C (normative):	Mitigation technique.....	64
C.1	Introduction	64
C.2	Principle of operation	64
C.3	Method 1 - Scanning band 918 MHz to 925 MHz.....	64
C.4	Method 2 - Scanning band 921 MHz to 925 MHz.....	64
C.5	Technical requirements	65
C.6	Requirements for Method 1.....	65
C.7	Requirements for Method 2.....	67
Annex D (informative):	Bibliography.....	68
History		69

Intellectual Property Rights

IPRs essential or potentially essential to the present document may have been declared to ETSI. The information pertaining to these essential IPRs, if any, is publicly available for **ETSI members and non-members**, and can be found in ETSI SR 000 314: "*Intellectual Property Rights (IPRs); Essential, or potentially Essential, IPRs notified to ETSI in respect of ETSI standards*", which is available from the ETSI Secretariat. Latest updates are available on the ETSI Web server (<https://ipr.etsi.org/>).

Pursuant to the ETSI IPR Policy, no investigation, including IPR searches, has been carried out by ETSI. No guarantee can be given as to the existence of other IPRs not referenced in ETSI SR 000 314 (or the updates on the ETSI Web server) which are, or may be, or may become, essential to the present document.

Foreword

This Harmonised European Standard (EN) has been produced by ETSI Technical Committee Electromagnetic compatibility and Radio spectrum Matters (ERM).

The present document has been prepared under the Commission's standardisation request C(2015) 5376 final [i.10] to provide one voluntary means of conforming to the essential requirements of Directive 2014/53/EU on the harmonisation of the laws of the Member States relating to the making available on the market of radio equipment and repealing Directive 1999/5/EC [i.3].

Once the present document is cited in the Official Journal of the European Union under that Directive, compliance with the normative clauses of the present document given in table A.1 confers, within the limits of the scope of the present document, a presumption of conformity with the corresponding essential requirements of that Directive, and associated EFTA regulations.

The present document replaces all previous versions of ETSI EN 302 208 Parts 1 and 2.

National transposition dates	
Date of adoption of this EN:	23 May 2016
Date of latest announcement of this EN (doa):	31 August 2016
Date of latest publication of new National Standard or endorsement of this EN (dop/e):	28 February 2017
Date of withdrawal of any conflicting National Standard (dow):	28 February 2018

Modal verbs terminology

In the present document "**shall**", "**shall not**", "**should**", "**should not**", "**may**", "**need not**", "**will**", "**will not**", "**can**" and "**cannot**" are to be interpreted as described in clause 3.2 of the [ETSI Drafting Rules](#) (Verbal forms for the expression of provisions).

"**must**" and "**must not**" are **NOT** allowed in ETSI deliverables except when used in direct citation.

1 Scope

The present document covers the minimum characteristics considered necessary in order to make the best use of the available frequencies. It does not necessarily include all the characteristics that may be required by a user, nor does it necessarily represent the optimum performance achievable.

Radio frequency identification products covered within the present document are considered by definition short-range devices. Power limits up to a maximum of 2 W e.r.p. are specified for this equipment in the frequency band 865 MHz to 868 MHz and up to a maximum of 4 W e.r.p. in the frequency band 915 MHz to 921 MHz. The frequency usage conditions for RFIDs in the band 865 MHz to 868 MHz are EU wide harmonised according to 2006/804/EC [i.12].

It should be noted that the frequency band 915 MHz to 921 MHz has only a limited implementation status within the European Union and the CEPT countries. ERC/REC 70-03 [i.9] provides in appendix 1 an overview of countries where the band is implemented.

The present document applies to RFID interrogators and tags operating together as a system. For each specified band, four high power channels are made available for use by interrogators. The tags respond with a modulated signal preferably in the adjacent low power channels. Interrogators may be used with either integral or external antennas.

The types of equipment covered by the present document are as follows:

- fixed interrogators;
- portable interrogators;
- batteryless tags;
- battery assisted tags;
- battery powered tags.

These radio equipment are capable of operating in the frequency ranges given in table 1.

Table 1: Frequencies of operation

Equipment	Operating frequencies
Interrogator Transmit channel 4	865,6 MHz to 865,8 MHz
Interrogator Transmit channel 7	866,2 MHz to 866,4 MHz
Interrogator Transmit channel 10	866,8 MHz to 867,0 MHz
Interrogator Transmit channel 13	867,4 MHz to 867,6 MHz
Interrogator Receive	865,2 MHz to 868,0 MHz
Tag Transmit and receive	865,2 MHz to 868,0 MHz
Interrogator Transmit channel 3	916,1 MHz to 916,5 MHz
Interrogator Transmit channel 6	917,3 MHz to 917,7 MHz
Interrogator Transmit channel 9	918,5 MHz to 918,9 MHz
Interrogator Transmit channel 12	919,7 MHz to 920,1 MHz
Interrogator Receive	915,3 MHz to 925,0 MHz
Tag Transmit and receive	915,3 MHz to 920,9 MHz

The present document contains requirements to demonstrate that the specified radio equipment both effectively uses and supports the efficient use of radio spectrum in order to avoid harmful interference.

2 References

2.1 Normative references

References are either specific (identified by date of publication and/or edition number or version number) or non-specific. For specific references, only the cited version applies. For non-specific references, the latest version of the referenced document (including any amendments) applies.

Referenced documents which are not found to be publicly available in the expected location might be found at <http://docbox.etsi.org/Reference>.

NOTE: While any hyperlinks included in this clause were valid at the time of publication, ETSI cannot guarantee their long term validity.

The following referenced documents are necessary for the application of the present document.

- [1] ETSI TR 102 273 (V1.2.1) (12-2001) (all parts): "Electromagnetic compatibility and Radio spectrum Matters (ERM); Improvement on Radiated Methods of Measurement (using test site) and evaluation of the corresponding measurement uncertainties".
- [2] ANSI C63.5-2006: "American National Standard for Calibration of Antennas Used for Radiated Emission Measurements in Electro Magnetic Interference".
- [3] ETSI TS 144 018 (V11.5.0) (07-2013): "Digital cellular telecommunications system (Phase 2+); Mobile radio interface layer 3 specification; Radio Resource Control (RRC) protocol (3GPP TS 44.018 version 11.5.0 Release 11)".

2.2 Informative references

References are either specific (identified by date of publication and/or edition number or version number) or non-specific. For specific references, only the cited version applies. For non-specific references, the latest version of the referenced document (including any amendments) applies.

NOTE: While any hyperlinks included in this clause were valid at the time of publication, ETSI cannot guarantee their long term validity.

The following referenced documents are not necessary for the application of the present document but they assist the user with regard to a particular subject area.

- [i.1] Void.
- [i.2] Void.
- [i.3] Directive 2014/53/EU of the European Parliament and of the Council of 16 April 2014 on the harmonisation of the laws of the Member States relating to the making available on the market of radio equipment and repealing Directive 1999/5/EC.
- [i.4] IEC 60489-3 Appendix J Second edition (1988): "Methods of measurement for radio equipment used in the mobile services. Part 3: Receivers for A3E or F3E emissions" (pages 156 to 164).
- [i.5] ETSI TR 100 028 (all parts) (V1.4.1): "Electromagnetic compatibility and Radio spectrum Matters (ERM); Uncertainties in the measurement of mobile radio equipment characteristics".
- [i.6] ETSI TR 100 028-2 (V1.4.1): "Electromagnetic compatibility and Radio spectrum Matters (ERM); Uncertainties in the measurement of mobile radio equipment characteristics; Part 2".
- [i.7] ETSI TS 102 902 (V1.2.1): "Electromagnetic compatibility and Radio spectrum Matters (ERM); Methods, parameters and test procedures for cognitive interference mitigation towards ER-GSM for use by UHF RFID using Detect-And-Avoid (DAA) or other similar techniques".
- [i.8] EIRENE System Requirements Specification Version 15.1.

- [i.9] CEPT/ERC/REC 70-03: "Short Range Devices (SRD)".
- [i.10] Commission implementing Decision C(2015) 5376 final of 4.8.2015 on a standardisation request to the European Committee for Electrotechnical Standardisation and to the European Telecommunications Standards Institute as regards radio equipment in support of Directive 2014/53/EU of the European Parliament and of the Council.
- [i.11] MPT 1314: "Performance Specification Transmitting and receiving equipment for use in the PMR Local Communication Service", Revised and reprinted December 1997.
- [i.12] 2006/804/EC: "Commission Decision of 23 November 2006 on harmonisation of the radio spectrum for radio frequency identification (RFID) devices operating in the ultra high frequency (UHF) band".

3 Definitions, symbols and abbreviations

3.1 Definitions

For the purposes of the present document, the following terms and definitions apply:

adaptive frequency agility: technique that allows an interrogator to change its frequency of operation automatically from one channel to another

battery assisted tag: transponder that includes a battery to enhance its receive performance and power its internal circuitry

batteryless tag: transponder that derives all of the power necessary for its operation from the field generated by an interrogator

battery powered tag: transponder that uses the power from its battery to perform all of its operational functions

conducted measurements: measurements which are made using a direct 50 Ω connection to the equipment under test

dedicated antenna: removable antenna supplied and type tested with the radio equipment, designed as an indispensable part of the equipment

dense interrogator mode: RFID operating mode in which multiple interrogators can transmit simultaneously in the same channel while tags respond in the adjacent channels

designated frequency band: frequency band within which the emission by a device is authorized

effective radiated power: product of the power supplied to the antenna and its gain relative to a half wave dipole in the direction of maximum gain

ER-GSM: extended band of 918 MHz to 960 MHz used by the railways

external antenna: antenna that may be connected to an interrogator via its external connector

Full Tests (FT): all tests specified in the present document

global scroll: test mode in which an interrogator is able to read the same tag continuously

integral antenna: permanent fixed antenna, which may be built-in, designed as an indispensable part of the equipment

interrogator: equipment that will activate an adjacent tag and read its data

NOTE: It may also enter or modify the information in a tag.

Limited Tests (LT): Tests that include:

- transmitter frequency error and frequency stability under low voltage conditions for mains operated equipment, see clause 4.3.1 of the present document;

- transmitter frequency stability under low voltage conditions, see clause 4.3.2 of the present document;
- transmitter effective radiated power, see clause 4.3.3 of the present document.

lower band: frequency range 865,0 MHz to 868,0 MHz designated for use by RFID

provider: manufacturer, or his authorized representative or person responsible for placing on the market

radiated measurements: measurements which involve the absolute measurement of a radiated field

R-GSM: interoperable band of 921 MHz to 960 MHz used by the railways

scan mode: specific test mode of an interrogator that detects a signal on a pre-selected channel and transmits automatically on another channel

NOTE: See clause C.3.

tag: transponder that holds data and responds to an interrogation signal

talk mode: transmission of intentional radiation by an interrogator

upper band: frequency range 915,0 MHz to 921,0 MHz designated for use by RFID.

3.2 Symbols

For the purposes of the present document, the following symbols apply:

dB	decibel
d	distance
f	frequency measured under normal test conditions
f _c	centre frequency of carrier transmitted by interrogator
f _e	the maximum frequency drift as measured in clause 5.5.2
Ω	Ohms
λ	wavelength

3.3 Abbreviations

For the purposes of the present document, the following abbreviations apply:

AM	amplitude modulation
ANSI	American National Standards Institute
ARFCN	Absolute Radio Frequency Channel Number
BCCH	Broadcast Control Channel
BER	Bit Error Ratio
BTS	Base Transceiver Station
BW	Bandwidth
CEPT	European Conference of Postal and Telecommunications administrations
C_L	Total cable loss in dB
DAA	Detect and Avoid
e.r.p.	effective radiated power
EMC	ElectroMagnetic Compatibility
emf	electromotive force
ERC	European Radio communication Committee
ER-GSM	Extended Railways GSM
EUT	Equipment Under Test
FT	Full Tests
FTZ	Foreign Trade Zone (sometimes called Free Trade Zone)
G_{IC}	Gain of a circular antenna in dBic
GSM-R	Global System for Mobile communication for Railways applications
IE	Information element
LT	Limited Tests
OATS	Open Area Test Site

ppm	part per million
RBW	Resolution Bandwidth
RF	Radio Frequency
RFID	Radio Frequency Identification
R-GSM	Railway GSM RMS
	Root mean square
SRD	Short Range Device
TCH	Traffic Channel
TX	Transmitter
VSWR	Voltage Standing Wave Ratio
UHF	Ultra High Frequency

4 Technical requirements specifications

4.1 Environmental profile

The technical requirements of the present document apply under the environmental profile for operation of the equipment, which shall be declared by the manufacturer. The equipment shall comply with all the technical requirements of the present document at all times when operating within the boundary limits of the declared operational environmental profile.

4.2 General requirements

4.2.1 Conformance requirements

Interrogators shall transmit on any of the high power channels specified in clause 4.2.2 for the purpose of communicating with tags at power levels up to the limits specified in clause 4.3.3.3.

When operating in the lower band, 865 MHz to 868 MHz, an interrogator may transmit a continuous signal on any of the high power channels for a period not exceeding the limit defined in clause 4.3.7.3. At the end of the transmission the interrogator shall not transmit again on the same channel for the period defined in figure 3 of clause 4.3.7.3. Alternatively the interrogator may switch immediately to any one of the other high power channels and send a further continuous transmission in accordance with the requirements of clause 4.3.7.3. There is no limit to the number of times that this process may be repeated.

For the lower band interrogators shall support trigger techniques that indicate the presence or arrival of objects that may be tagged. Irrespective of the application, an interrogator operating in the lower band shall stop transmitting after it has ceased to read any further tags, as specified in clause 4.3.7.3.

For operation in the upper band, 915 MHz to 921 MHz, interrogators shall transmit on any of the high power channels but for no longer than is necessary to complete the intended operation.

NOTE: The frequency band 915 MHz to 921 MHz has only a limited implementation status within the European Union and the CEPT countries. ERC/REC 70-03 [i.9] provides in appendix 1 an overview of countries where the band is implemented.

In some member states the upper sub-band 918 MHz to 921 MHz is allocated to the railways for ER-GSM. For the case that a frequency allocation is available in those countries for RFID, sharing of this sub-band by RFID with ER-GSM is permitted provided RFID systems operate in accordance with agreed mitigation techniques. These are specified in clause 4.3.8.3 and annex C and require interrogators to use ER-GSM receiver(s), or equivalent, covering either the frequency range 918 MHz to 921 MHz or R-GSM receivers covering the frequency range 921 MHz to 925 MHz. Each interrogator may be fitted with its own (E)R-GSM receiver module. Alternatively it is permissible for a single (E)R-GSM receiver to monitor BCCH messages and serve all of the interrogators on a site. Where this applies the antenna of the (E)R-GSM receiver shall be positioned to ensure maximum coverage.

In some member states parts of the upper band are allocated for the exclusive use of the military and government services. This applies predominantly to the lower sub-band 915 MHz to 918 MHz. Interrogators capable of operating in this band shall provide a means to prevent operation at the restricted frequencies in the applicable member states.

Where an interrogator is only able to transmit on a single band, testing shall be performed in the applicable band.

In a preferred method of operation tags, which are activated by an interrogator transmitting in a high power channel, respond in the adjacent low power channels. This technique is called the dense interrogator mode. It has the benefit of separating the frequencies of transmission of the interrogators and tags, allowing multiple interrogators to share the same channel thereby improving system performance. It also minimizes the generation of inter-modulation products, which may disrupt the behaviour of tags.

Interrogators may also operate in a presence-sensing mode in which they periodically transmit to determine whether tags have entered their interrogation zones. When operating in this mode, interrogators shall restrict the length of each transmission to less than 1 second and the period between successive transmissions shall be no less than 100 ms. Once an interrogator has determined the presence of tags, it will commence its reading routine.

It is permissible for interrogators to transmit simultaneously in both the lower and upper bands.

4.2.2 Designated frequencies

4.2.2.1 Lower band

Interrogators operating in the lower band shall use any of the four specified high power channels illustrated in figure 1. The centre frequency of the lowest channel shall be 865,7 MHz and the bandwidth of each high power channel shall be 200 kHz. The remaining three high power channels shall be spaced at equal intervals of 600 kHz. Tags should respond in the dense interrogator mode within the low power channels.

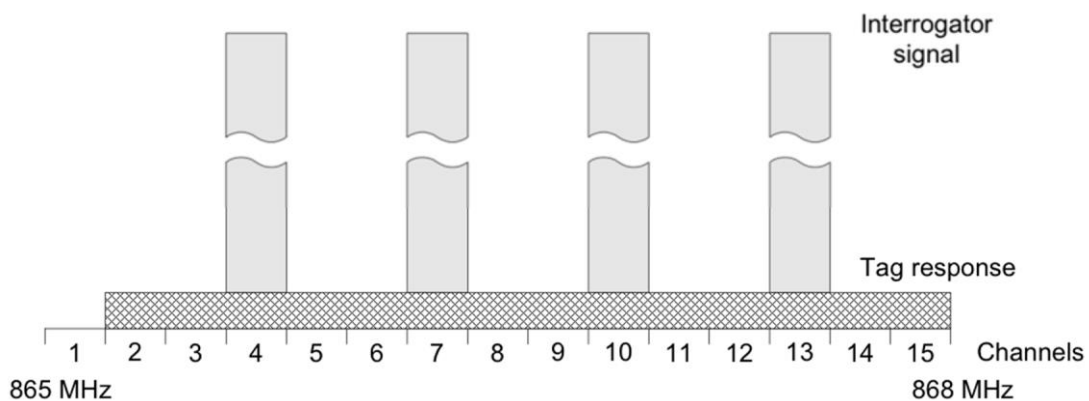

Figure 1: Channel plan for lower band

4.2.2.2 Upper band

For the upper band the centre frequency of the lowest channel shall be 916,3 MHz and the bandwidth of each high power channel shall be 400 kHz. The remaining three high power channels shall be spaced at equal intervals of 1,2 MHz. Tags shall respond in the dense interrogator mode within the low power channels.

A diagram of the channel plan for the upper band is shown in figure 2.

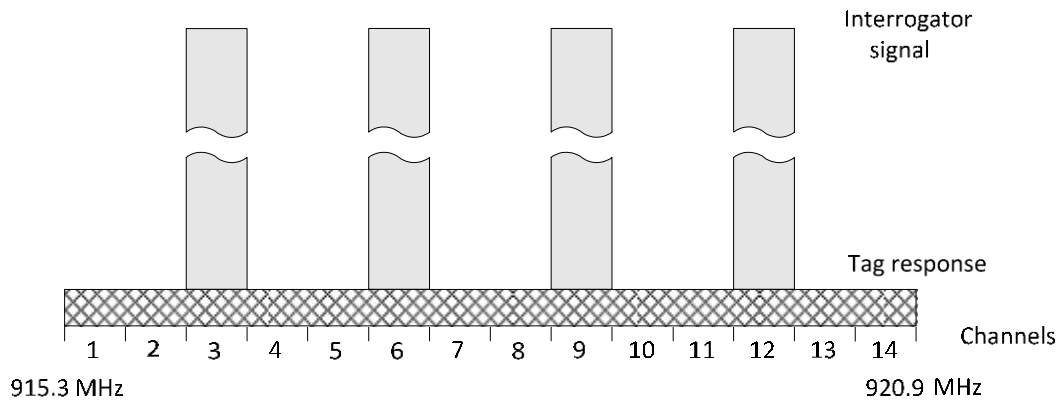

Figure 2: Channel plan for upper band

4.2.3 Testing of operational frequencies

Figures 3 and 4 shows the centre frequencies of the four high power channels permitted for use by interrogators within the two bands designated for RFID. Full (FT) and Limited (LT) Tests, as defined in clause 3.1, shall be carried out in the applicable channels at the frequencies shown in figures 3 and 4.

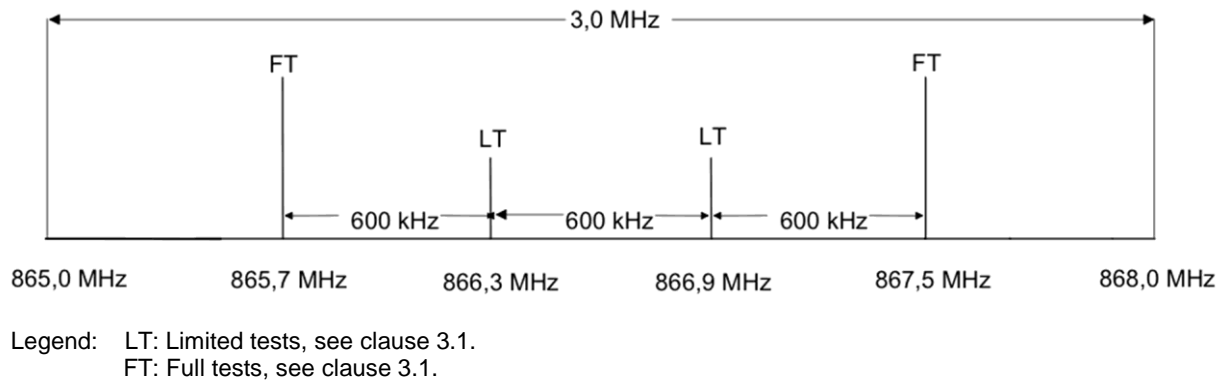

Figure 3: Tests on a single sample for equipment in the lower band

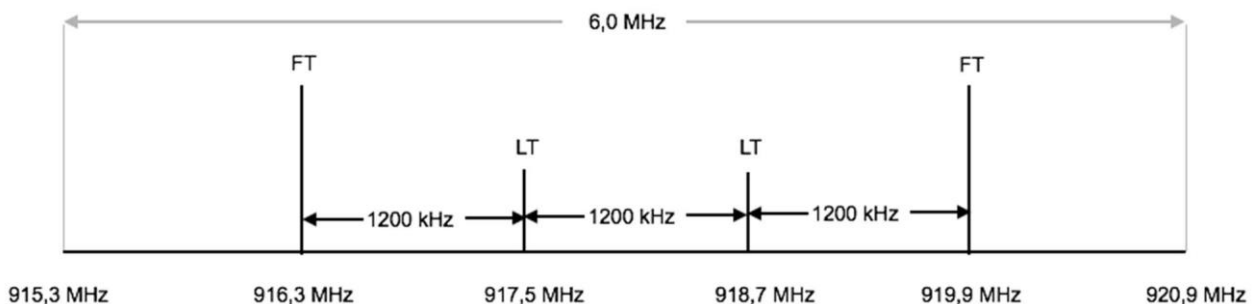

Figure 4: Tests on a single sample for equipment in the upper band

4.2.4 General considerations

The equipment tested shall be designed, constructed and manufactured in accordance with good engineering practice and with the aim of minimizing harmful interference to other equipment and services.

Each equipment submitted for testing, where applicable, shall fulfil the requirements of the present document on all frequencies over which it is intended to operate.

Where a manufacturer declares multiple operating frequencies, or highest and lowest operating frequencies and channel spacing, the difference between the values of two adjacent operating frequencies cannot be less than the value of the declared channel spacing.

4.2.5 Choice of samples for test suite

The provider shall supply one or more samples of the equipment, as appropriate, for testing.

If an equipment has several optional features considered not to affect the RF parameters then tests need only be performed on the equipment configured with that combination of features considered to be the most complex, as proposed by the provider and agreed by the test laboratory. Equipment that does not have an external 50 Ω RF connector (integral antenna equipment), shall be presented for testing in accordance with clause 5.4.

4.3 Transmitter conformance requirements

4.3.1 Frequency error

4.3.1.1 Applicability

The frequency tolerance requirement shall apply to interrogators able to transmit a modulated and un-modulated signal.

4.3.1.2 Definition

The frequency error, known as frequency drift, is the difference between the frequency of the device under test measured under normal test conditions (see clause 5.1.1.1) and the frequency measured under extreme test conditions (see clause 5.1.1.2).

4.3.1.3 Limits

The maximum permitted frequency error, defined as the absolute value of $f_e - f$, shall not exceed ± 10 ppm relative to the nominal centre frequency of each of the applicable channels, where:

- f = the frequency measured under normal test conditions (see clause 5.1.1.1).
- f_e = the maximum frequency drift as measured in clause 5.1.1.2.

NOTE: Where multiple interrogators are co-located, tighter limits may be necessary to avoid unacceptable beat tones.

4.3.1.4 Conformance

The conformance test suite for frequency error shall be as defined in clause 5.5.1 of the present document.

4.3.2 Frequency stability under low voltage conditions

4.3.2.1 Applicability

The frequency stability requirement shall apply to interrogators

4.3.2.2 Definition

The frequency stability under low voltage conditions is the ability of the equipment to remain within its permitted frequency limits when the battery voltage falls below the lowest extreme voltage level.

4.3.2.3 Limits

The equipment shall either:

- transmit with a carrier frequency within the limits of ± 10 ppm whilst the radiated or conducted power is below the spurious emission limits; or
- automatically cease to function below the provider's declared operating voltage.

NOTE: Where multiple interrogators are co-located, tighter limits may be necessary to avoid unacceptable beat tones.

4.3.2.4 Conformance

The conformance test suite for frequency stability shall be as defined in clause 5.5.2 of the present document.

4.3.3 Effective radiated power

4.3.3.1 Applicability

The effective radiated power requirement shall apply to all interrogators.

4.3.3.2 Definition

The effective radiated power is the product of the power supplied to the antenna and its gain relative to a half wave dipole in the direction of maximum gain.

4.3.3.3 Limits

4.3.3.3.1 Operation in the lower band (865 MHz to 868 MHz)

The effective radiated power on each of the four high power channels specified in figure 3 shall not exceed 33 dBm e.r.p. specified in a bandwidth of 200 kHz.

4.3.3.3.2 Operation in the upper band (915 MHz to 928 MHz)

The effective radiated power on each of the four high power channels specified in figure 4 shall not exceed 36 dBm e.r.p. specified in a bandwidth of 400 kHz.

4.3.3.4 Conformance

The conformance test suite for the effective radiated power requirement shall be as defined in clause 5.5.3 of the present document.

4.3.4 Transmitter antenna beam-width

4.3.4.1 Applicability

The requirements for transmitter antenna beam-width shall apply to antennas connected to interrogators.

4.3.4.2 Definition

The beam-width of an antenna is the [angle](#) between the two half-power (-3 dB) points of the [main lobe](#), when referenced to the peak [effective radiated power](#) of the main lobe.

4.3.4.3 Limits

The beam-width(s) of the antenna(s) in the horizontal orientation for the lower band shall comply with the following limits:

- For transmissions ≤ 500 mW e.r.p. there shall be no restriction on beam-width.
- For transmissions of > 500 mW e.r.p. to $\leq 1\,000$ mW e.r.p. beam-widths shall be $\leq 180^\circ$
- For transmissions of $> 1\,000$ mW e.r.p. to $2\,000$ mW e.r.p. beam-widths shall be $\leq 90^\circ$

The beam-width(s) of the antenna(s) in the horizontal orientation in the upper band shall comply with the following limits:

- For transmissions $\leq 1\,000$ mW e.r.p. there shall be no restriction on beam-width.
- For transmissions of $> 1\,000$ mW e.r.p. to $\leq 2\,000$ mW e.r.p. beam-widths shall be $\leq 180^\circ$
- For transmissions of $> 2\,000$ mW e.r.p. to $4\,000$ mW e.r.p. beam-widths shall be $\leq 90^\circ$

4.3.4.4 Conformance

The conformance test suite for the transmitter antenna beam-width shall be as defined in clause 5.5.4 of the present document.

4.3.5 Transmitter spectrum masks

4.3.5.1 Applicability

The requirement for transmitter spectrum masks shall apply to all interrogators

4.3.5.2 Definition

A spectrum mask is a mathematically defined set of lines applied to the levels of radio transmissions

4.3.5.3 Limits

4.3.5.3.1 Limits for lower band (865 MHz to 868 MHz)

For measurements performed in the lower band, the absolute levels of RF power at any frequency shall not exceed the limits defined by the envelope in the spectrum mask at figure 5 in which the Y axis is scaled in dBm e.r.p. and referenced to 1 kHz resolution bandwidth.

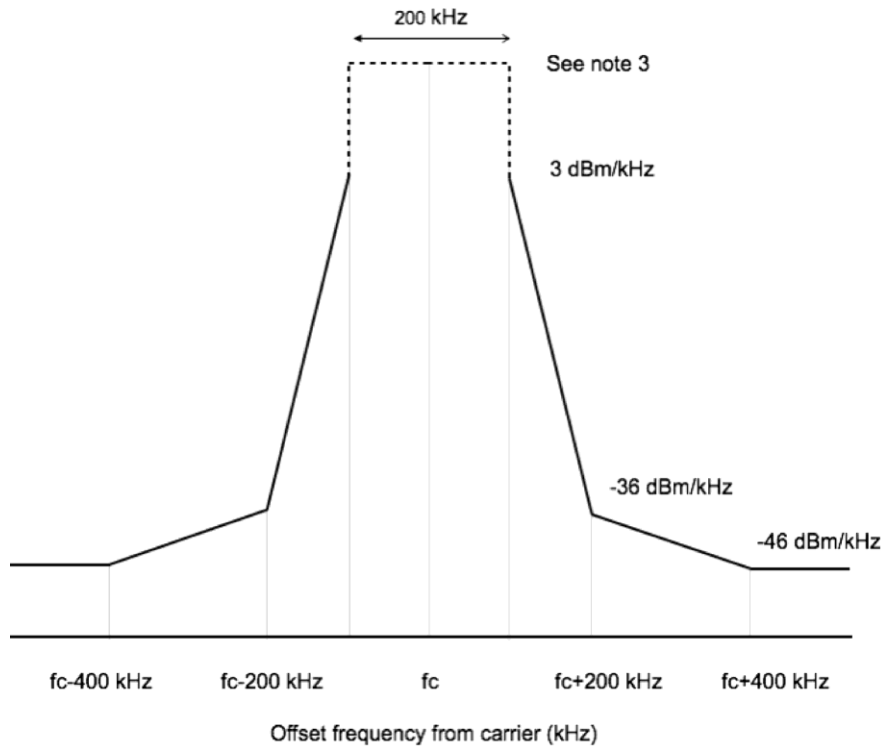

NOTE 1: Where f_c is the centre frequency of the carrier transmitted by the interrogator applicable over the frequency range $f_c \pm 500$ kHz.

NOTE 2: All limits are shown with reference to a resolution bandwidth of 1 kHz

NOTE 3: Measurements in the frequency range $f_c \pm 100$ kHz shall be made in accordance with clauses 4.3.3 and 5.5.3.

Figure 5: Spectrum mask for modulated signals in the lower band

4.3.5.3.2 Limits for upper band (915 MHz to 921 MHz)

For measurements performed in the upper band the absolute levels of RF power at any frequency shall not exceed the limits defined by the envelope in the spectrum mask at figure 6 in which the Y axis is scaled in dBm e.r.p. and referenced to 1 kHz resolution bandwidth.

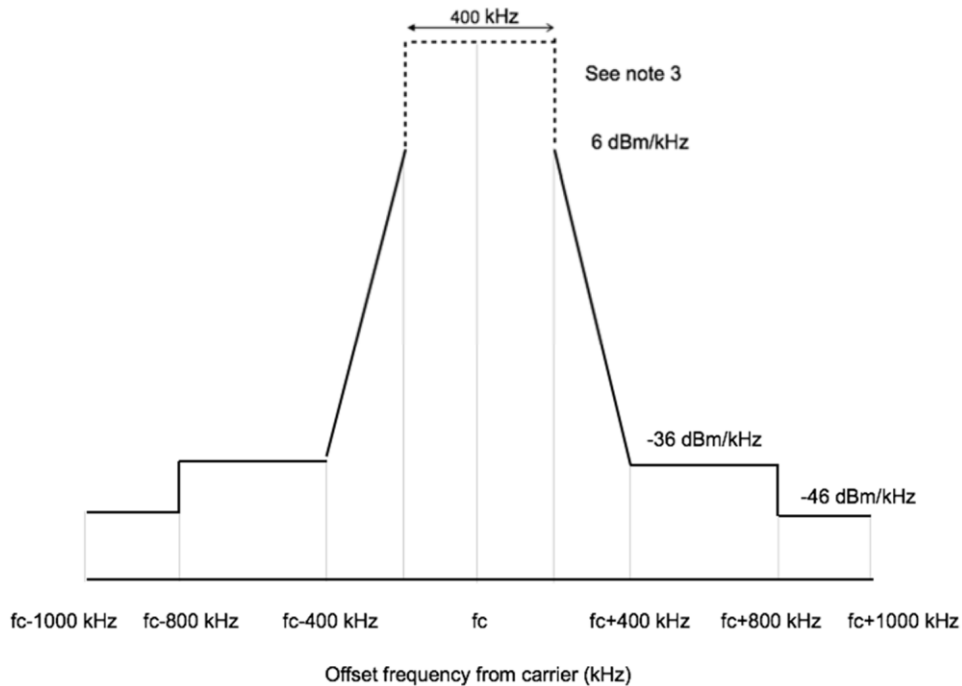

NOTE 1: Where f_c is the centre frequency of the carrier transmitted by the interrogator applicable over the frequency range $f_c \pm 1\,000$ kHz.

NOTE 2: All limits are shown with reference to a resolution bandwidth of 1 kHz.

NOTE 3: Measurements in the frequency range $f_c \pm 200$ kHz shall be made in accordance with clauses 4.3.3 and 5.5.3.

Figure 6: Spectrum mask for modulated signals in the upper band

4.3.5.4 Conformance

The conformance test suite for the transmitter spectrum masks shall be as defined in clause 5.5.5 of the present document.

4.3.6 Transmitter spurious emissions

4.3.6.1 Applicability

The requirements for transmitter spurious emissions shall apply to all interrogators

4.3.6.2 Definition

A spurious emission is any signal produced by the interrogator that falls outside of the band on which the equipment is meant to operate.

4.3.6.3 Limits

The level of any spurious emission, conducted or radiated, outside the relevant necessary bands shall not exceed the values given in table 2.

Table 2: Spurious emission limits in e.r.p.

State	47 MHz to 74 MHz 87,5 MHz to 118 MHz 174 MHz to 230 MHz 470 MHz to 862 MHz	Other frequencies below 1 000 MHz	Frequencies above 1 000 MHz
Operating	4 nW (-54 dBm)	250 nW (-36 dBm)	1 μ W (-30 dBm)
Standby	2 nW (-57 dBm)	2 nW (-57 dBm)	20 nW (-47 dBm)

NOTE: For frequencies below 1 000 MHz limits are specified for a RBW of 100 kHz. Above 1 000 MHz a RBW of 1 MHz applies.

4.3.6.4 Conformance

The conformance test suite for the spurious emission limits shall be as defined in clause 5.5.6 of the present document.

4.3.7 Transmission times

4.3.7.1 Applicability

The requirement for transmission times shall apply to all interrogators.

4.3.7.2 Definition

The transmission time is the period of continuous transmission generated by an interrogator.

NOTE: The maximum period of continuous transmission and the period between consecutive transmissions on the same channel are specified in order to ensure most efficient use of available channels for the general benefit of all users.

4.3.7.3 Limits

For interrogators designed to operate in the lower band the manufacturer shall declare that the measured length of transmission at step 3 of clause 5.5.7.1 is no greater than is required to read the tags present in the field and to verify that there are no additional tags present.

In addition, the maximum length of continuous transmission and the interval between repeated transmissions measured at step 6 of clause 5.5.7.1 shall comply with the two limits in figure 7.

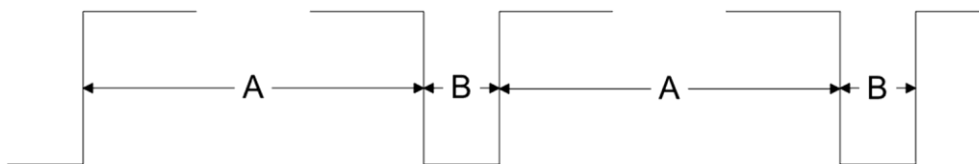

Figure 7: Repeated transmissions on the same channel

Where:

- 1) the on-duration of A shall not exceed 4 s;
- 2) the off-duration of B shall be not less than 100 ms.

In some applications (i.e. conveyor systems) it may be necessary for interrogators to transmit while tags are not present. To accommodate such requirements, manufacturers shall include within interrogators a means to minimize the overall length of transmission commensurate with the application. This may include the provision of trigger mechanisms within interrogators to initiate transmissions.

It is permitted for an interrogator to switch its transmission repeatedly between channels at intervals not exceeding 4 s. An interrogator shall not return to a previous channel within a period of less than 100 ms.

There is no specific limit to the length of transmission for interrogators when transmitting in the upper band. However interrogators shall transmit for no longer than is necessary to perform the intended operation.

4.3.7.4 Conformance

The conformance test suite for the transmission times shall be as defined in clause 5.5.7 of the present document.

4.3.8 Mitigation using DAA

4.3.8.1 Applicability

This requirement applies to all interrogators that are sharing the sub-band 918 MHz to 921 MHz with ER-GSM.

4.3.8.2 Definition

A set of technologies designed to avoid interference by interrogators to ER-GSM.

4.3.8.3 Limits

The GSM-R receiver and interrogator under test shall detect and decode BCCH signals correctly at levels down to -98 dBm.

- 1) **Method 1.** For the tests in accordance with Method 1, the interrogator shall prevent transmission on either of its designated channels if they are within 700 kHz of an allocated ER-GSM channel. Manufacturers shall declare that their interrogators shall automatically perform a scan of the band 918 MHz to 925 MHz as specified in clause C.3 at least once every 24 hours.
- 2) **Method 2.** For the tests in accordance with Method 2 the interrogator shall prevent transmission on either of its designated channels if they are within 700 kHz of an allocated ER-GSM channel. In addition the interrogator shall prevent transmission on both designated channels in the ER-GSM band if it detects that a BTS has been allocated a channel within the frequency range 918 MHz to 921 MHz. Manufacturers shall declare that their interrogators shall automatically perform a scan of the band 918 MHz to 925 MHz as specified in clause C.4 at least once every 24 hours.

4.3.8.4 Conformance

The conformance test suite for the mitigation requirement of the interrogator shall be as defined in clause 5.5.8 of the present document.

4.4 Receiver conformance requirements

4.4.1 Adjacent channel selectivity

4.4.1.1 Applicability

This requirement applies to all interrogators.

4.4.1.2 Definition

The adjacent channel selectivity is a measure of the capability of the receiver in an interrogator to identify a tag while rejecting an unwanted signal from another device transmitting in one of the adjacent high power channels. The adjacent channel in the lower band shall be at a frequency of $\pm 0,6$ MHz from the centre frequency of the selected channel. For the upper band the adjacent channel shall be at a frequency of $\pm 1,2$ MHz from the centre frequency of the selected channel.

4.4.1.3 Limits

The adjacent channel selectivity measured at the receiver of the interrogator shall be equal to or better than -26 dBm.

4.4.1.4 Conformance

The conformance test suite for the adjacent channel selectivity shall be as defined in clause 5.6.1 of the present document.

4.4.2 Blocking or desensitization

4.4.2.1 Applicability

This requirement applies to all interrogators.

4.4.2.2 Definition

Blocking or desensitization is a measure of the capability of the receiver to identify a tag in the presence of an unwanted input signal at frequencies other than those of the spurious responses or in the adjacent channels under normal test conditions.

4.4.2.3 Limits

The blocking level measured at the receiver to the interrogator under the above specified conditions shall be equal to or better than the following limits:

For (fc ± 2MHz)	-23 dBm
For (fc ± 5MHz)	-14 dBm
For (fc ± 10MHz)	-8 dBm

4.4.2.4 Conformance

The conformance test suite for blocking or desensitization shall be as defined in clause 5.6.2 of the present document.

4.4.3 Spurious emissions

4.4.3.1 Applicability

This requirement applies to interrogators with a specific receive only mode of operation. In all other cases the receiver shall be tested together with the transmitter in its operating mode as specified in clause 4.3.6.

4.4.3.2 Definition

Spurious emissions from the receiver of an interrogator are emissions at any frequency when the equipment is not in the transmit mode.

4.4.3.3 Limits

The power of any spurious emission, radiated or conducted, shall not exceed the values given below:

- a) 2 nW e.r.p. below 1 000 MHz;
- b) 20 nW e.r.p. above 1 000 MHz.

4.4.3.4 Conformance

The conformance test suite for spurious emissions shall be as defined in clause 5.5.6 of the present document.

4.5 Tag conformance requirements

4.5.1 Radiated power (e.r.p.)

4.5.1.1 Applicability

This requirement applies to all RFID tags operating at UHF.

4.5.1.2 Definition

The effective radiated power of a tag is the power radiated by its antenna in its direction of maximum gain under specified conditions of measurement.

4.5.1.3 Limits

For the lower band the radiated power of the tag shall not exceed -20 dBm e.r.p. which is equivalent to a power spectrum density of -25 dBm/100 kHz e.r.p.

For the upper band the radiated power of the tag shall not exceed -10 dBm e.r.p. which is equivalent to a power spectrum density of -18 dBm/100 kHz e.r.p.

4.5.1.4 Conformance

The conformance test suite for the radiated power of a tag shall be as defined in clause 5.7.1 of the present document.

4.5.2 Unwanted emissions

4.5.2.1 Applicability

This requirement applies to all RFID tags operating at UHF.

4.5.2.2 Definition

The unwanted emissions from a tag include both the out-of-band and the spurious emissions from a continuously modulated tag measured outside its wanted carrier frequency and associated sidebands when the tag is orientated for optimum coupling at a defined distance from the antenna of an interrogator, which is transmitting a continuous unmodulated carrier at a specified power level.

4.5.2.3 Limits

For the lower band the unwanted emissions from the tag under the above specified conditions at any frequency outside the band $f_c - 400$ kHz to $f_c + 400$ kHz shall not exceed the levels defined in the spectrum mask in figure 8.

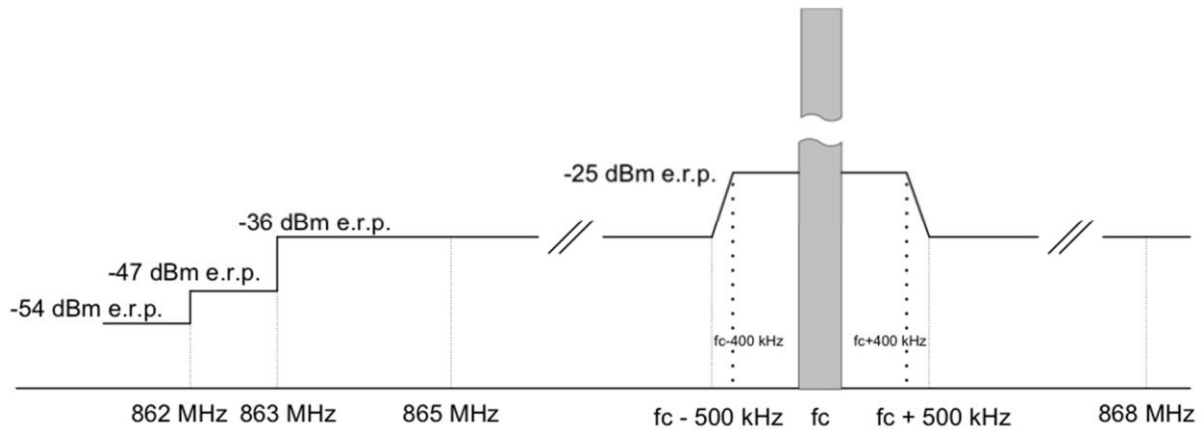

NOTE 1: f_c is the centre frequency of the carrier transmitted by the interrogator.

NOTE 2: The transmit channel occupied by the interrogator is shown in grey.

NOTE 3: All power levels in the unwanted domain relate to the resolution bandwidths in figure 10.

Figure 8: Spectrum mask for tag for the lower band

For the upper band the unwanted emissions from the tag under the above specified conditions at any frequency outside the band $f_c - 800$ kHz to $f_c + 800$ kHz shall not exceed the levels defined in the spectrum mask in figure 9.

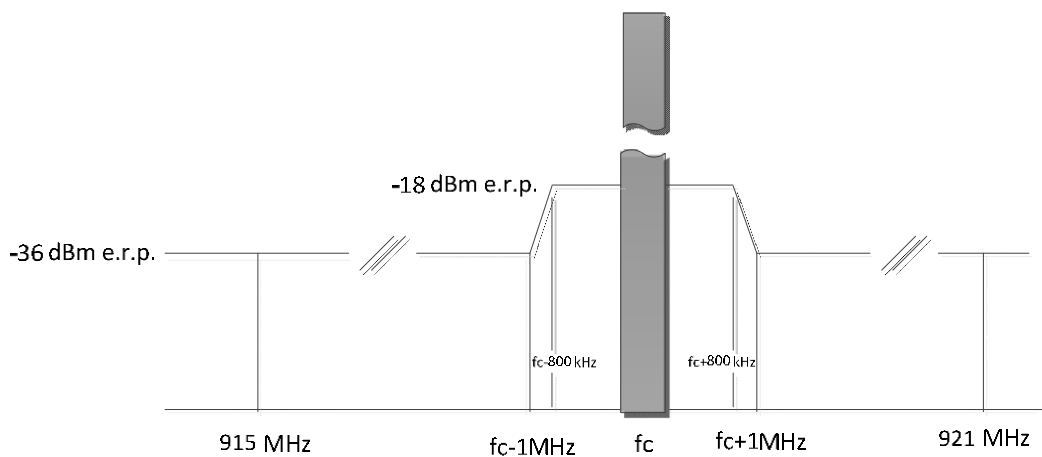

NOTE 1: f_c is the centre frequency of the carrier transmitted by the interrogator.

NOTE 2: The transmit channel occupied by the interrogator is shown in grey.

NOTE 3: All power levels in the unwanted domain relate to the resolution bandwidths in figure 11.

Figure 9: Spectrum mask for tag for the upper band

4.5.2.4 Conformance

The conformance test suite for the unwanted emissions from a tag shall be as defined in clause 5.7.2 of the present document.

5 Testing for compliance with technical requirements

5.1 Environmental conditions for testing

5.1.1 Normal and extreme test conditions

5.1.1.1 Normal test conditions

The normal temperature and humidity conditions for tests shall be any convenient combination of temperature and humidity within the following ranges:

- Temperature +15 °C to +35 °C;
- Relative humidity 20 % to 75 %.

When it is impracticable to carry out tests under these conditions, a note to this effect, stating the ambient temperature and relative humidity during the tests, shall be added to the test report.

5.1.1.2 Extreme temperatures

5.1.1.2.1 Procedure for tests at extreme temperatures

Before measurements are made the equipment shall have reached thermal balance in the test chamber. The equipment shall be switched off during the temperature stabilizing period.

In the case of equipment containing temperature stabilization circuits designed to operate continuously, the temperature stabilization circuits shall be switched on for 15 minutes after thermal balance has been obtained, and the equipment shall then meet the specified requirements.

If the thermal balance is not checked by measurements, a temperature stabilizing period of at least one hour, or such period as may be decided by the test laboratory, shall be allowed. The sequence of measurements shall be chosen, and the humidity content in the test chamber shall be controlled so that excessive condensation does not occur.

5.1.1.2.2 Procedure for equipment designed for continuous operation

If the provider states that the equipment is designed for continuous operation, the test procedure shall be as follows:

- Before tests at the upper extreme temperature the equipment shall be placed in the test chamber and left until thermal balance is attained. The equipment shall then be switched on in the transmit condition for a period of a half hour after which the equipment shall meet the specified requirements.
- For tests at the lower extreme temperature, the equipment shall be left in the test chamber until thermal balance is attained, then switched on for a period of one minute after which the equipment shall meet the specified requirements.

5.1.1.2.3 Procedure for equipment designed for intermittent operation

If the provider states that the equipment is designed for intermittent operation, the test procedure shall be as follows:

- Before tests at the upper extreme temperature the equipment shall be placed in the test chamber and left until thermal balance is attained in the oven. The equipment shall then either:
 - transmit on and off according to the providers declared duty cycle for a period of five minutes; or
 - if the provider's declared on period does not exceed one minute, then:

transmit in the on condition for a period not exceeding one minute, followed by a period in the off or standby mode for four minutes; after which the equipment shall meet the specified requirements;

- For tests at the lower extreme temperature, the equipment shall be left in the test chamber until thermal balance is attained, then switched to the standby or receive condition for one minute after which the equipment shall meet the specified requirements.

5.1.1.3 Extreme temperature ranges

For tests at extreme temperatures, measurements shall be made in accordance with the procedures specified in clause 5.1.1.2 at the upper and lower temperatures of one of the ranges specified in table 3.

Table 3: Extreme temperature ranges

Category	Temperature range
Category I (General):	-20 °C to +55 °C
Category II (Portable equipment):	-10 °C to +55 °C
Category III (Equipment for normal indoor use):	0 °C to +35 °C
NOTE: The term "equipment for normal indoor use" is taken to mean that the room temperature is controlled and the minimum indoor temperature is equal to or greater than 5 °C.	

In order to comply with the present document, the device shall meet the requirements over the appropriate temperature range stated in table 3. However, the provider may specify an alternative temperature range than those stated in table 3.

5.1.2 Test power sources

5.1.2.1 General requirements

During testing where possible the power source of the equipment shall be replaced by an external test power source capable of producing normal and extreme test voltages as specified in clauses 5.1.2.2 and 5.1.2.3.

The internal impedance of the external test power source shall be low enough for its effect on the test results to be negligible. For the purpose of the tests, the voltage of the external test power source shall be measured at the input terminals of the equipment. The external test power source shall be suitably de-coupled and applied as close to the equipment battery terminals as practicable. For radiated measurements, any external power leads shall be so arranged so as not to affect the measurements.

During tests, the test power source voltages shall be within a tolerance of $< \pm 1$ % relative to the voltage at the beginning of each test. The value of this tolerance can be critical for certain measurements. Using a smaller tolerance will provide a better uncertainty value for these measurements.

5.1.2.2 Normal test power source

5.1.2.2.1 Mains voltage

The normal test voltage for equipment to be connected to the mains shall be the nominal mains voltage. For the purpose of the present document, the nominal voltage shall be the declared voltage, or any of the declared voltages, for which the equipment was designed.

The frequency of the test power source corresponding to the ac mains shall be between 49 Hz and 51 Hz.

5.1.2.2.2 Regulated lead-acid battery power sources

When the radio equipment is intended for operation with the usual types of regulated lead-acid battery power source, the normal test voltage shall be 1,1 multiplied by the nominal voltage of the battery (6 V, 12 V, etc.).

5.1.2.2.3 Other power sources

For operation from other power sources or types of battery (primary or secondary), the normal test voltage shall be that declared by the equipment provider and where appropriate agreed by the accredited test laboratory. Such values shall be stated.

5.1.2.3 Extreme test power source

5.1.2.3.1 Mains voltage

The extreme test voltages for equipment to be connected to an ac mains source shall be the nominal mains voltage $\pm 10\%$.

5.1.2.3.2 Regulated lead-acid battery power sources and gel-cell battery power sources

When the radio equipment is intended for operation with the usual type of regulated lead-acid battery power sources, the extreme test voltages shall be 1,3 and 0,9 multiplied by the nominal voltage of the battery (6 V, 12 V, etc.).

For float charge applications using "gel-cell" type batteries, the extreme test voltages shall be 1,15 and 0,85 multiplied by the nominal voltage of the declared battery voltage.

5.1.2.3.3 Power sources using other types of batteries

The lower extreme test voltages for equipment with power sources using batteries shall be as follows:

- for equipment with a battery indicator, the end point voltage as indicated;
- for equipment without a battery indicator, the following end point voltage shall be used:
 - for the Leclanché or the lithium type of battery:
 - 0,85 multiplied by the nominal voltage of the battery;
 - for the nickel-cadmium type of battery:
 - 0,9 multiplied by the nominal voltage of the battery;
- for other types of battery, the lower extreme test voltage for the discharged condition shall be declared by the equipment provider.

The nominal voltage is considered to be the upper extreme test voltage in this case.

5.1.2.3.4 Other power sources

For equipment using other power sources, or capable of being operated from a variety of power sources, the extreme test voltages shall be those agreed between the equipment provider and the accredited test laboratory and shall be recorded in the test report.

5.1.3 Testing under extreme conditions

Unless stated otherwise, tests performed under extreme test conditions shall apply the worst-case temperature and voltage conditions simultaneously.

5.2 Interpretation of the measurement results

The interpretation of the results recorded in the test report for the measurements described in the present document shall be as follows:

- the measured value related to the corresponding limit shall be used to decide whether an equipment meets the requirements of the present document;
- the value of the measurement uncertainty for the measurement of each parameter shall be separately included in the test report;
- the value of the measurement uncertainty shall be, for each measurement, equal to or lower than the figures in table 4.

Table 4: Measurement uncertainty

Radio frequency	$\pm 1 \times 10^{-7}$
RF power, conducted	$\pm 1,5$ dB
Conducted spurious emission of transmitter, valid up to 6 GHz	± 3 dB
Conducted emission of receivers	± 3 dB
Radiated emission of transmitter, valid up to 6 GHz	± 6 dB
Radiated emission of receiver, valid up to 6 GHz	± 6 dB
RF level uncertainty for a given BER	$\pm 1,5$ dB
Temperature	± 1 °C
Humidity	± 10 %

For the test methods, according to the present document, the measurement uncertainty figures shall be calculated and shall correspond to an expansion factor (coverage factor) $k = 1,96$ or $k = 2$ (which provide confidence levels of respectively 95 % and 95,45 % in the case where the distributions characterizing the actual measurement uncertainties are normal (Gaussian)). Principles for the calculation of measurement uncertainty are contained in ETSI TR 100 028 [i.5], in particular in annex D of ETSI TR 100 028-2 [i.6].

Table 4 is based on such expansion factors.

5.3 Submission of equipment for testing

5.3.1 Mechanical and electrical design

5.3.1.1 General requirements

The equipment submitted by the provider shall be designed, constructed and manufactured in accordance with good engineering practice, and with the aim of minimizing harmful interference to other equipment and services.

Interrogators shall operate with the correct power source.

5.3.1.2 Controls

Those controls, which if maladjusted, may increase the interfering potential of the equipment, shall not be easily accessible to the user.

5.3.1.3 Transmitter shut-off facility

If the interrogator is equipped with an automatic transmitter shut-off facility, where appropriate, it should be made inoperative for the duration of the test.

5.3.1.4 Battery saving circuit

If the receiver is equipped with a battery-saving circuit, this circuit shall be made inoperative for the duration of the tests. In the case where this not possible, a proper test method shall be described and documented.

5.3.1.5 Declarations by the provider

The provider shall declare all necessary information concerning the equipment in respect of the technical requirements set out in the present document.

5.3.1.6 Auxiliary test equipment

All necessary test signal sources including sample tags and setting up information shall accompany the equipment when it is submitted for testing.

5.3.2 General conditions for testing of transmitters

5.3.2.1 Normal test signals and test modulation

The test-modulating signal is a signal that modulates a carrier and is dependent upon the type of equipment under test and also the measurement to be performed.

5.3.2.2 Normal test signals for data

Normal test signals shall represent the normal modulated carriers received both by the receiver of an interrogator and by a tag. They correspond to a single message triggered either manually or automatically. They are used for receiver methods of measurement where there is a need to transmit a single message repeatedly. This is achieved using a combined encoder and signal generator (for example a tag or interrogator) that shall be capable of supplying the test signal. Details of the test signal, including the data rate, modulation scheme and protocol, shall be supplied by the provider and described in the test report.

5.3.2.3 Artificial antenna

Where applicable, tests shall be carried out using an artificial antenna, which shall be a substantially non-reactive non-radiating load of 50 Ω connected to the antenna connector. The Voltage Standing Wave Ratio (VSWR) at the 50 Ω connector shall not be greater than 1,2:1 over the frequency range of the measurement.

5.3.2.4 Modes of operation of the transmitter

For the purposes of the measurements according to the present document there should be a means to operate the transmitter in an un-modulated state. The provider may also decide the method of achieving an un-modulated carrier, or special types of modulation patterns, the details of which shall be described in the test report (see clause 5.4.9). It may involve suitable temporary internal modifications of the equipment under test. If it is not possible to provide an un-modulated carrier then this shall be stated.

5.3.2.5 Test sites and general arrangements for radiated measurements

For guidance on radiation test sites, see annex B. Detailed descriptions of the radiated measurement arrangements are included in this annex.

5.3.2.6 Measuring receiver

The term measuring receiver refers to either a frequency selective voltmeter or a spectrum analyser. The reference bandwidth of the measuring receiver shall be as specified in the relevant clauses.

As technical performance varies according to environmental conditions, tests shall be carried out under a sufficient variety of environmental conditions as specified in the present document to give confidence of compliance for the affected technical requirements.

5.3.2.7 Testing of operational frequencies

Full (FT) and Limited (LT) Tests, as defined in clause 3.1, shall be carried out in the applicable channels at the frequencies shown in figures 3 and 4.

5.4 Presentation of equipment for testing

5.4.1 General requirements

Equipment submitted for testing shall fulfil the requirements of the present document on all frequencies over which it is intended to operate.

Providers shall select frequencies of operation in accordance with the channel plans defined in clause 4.2.2 and in accordance with the power levels defined in clause 4.3.3.3.

If equipment is designed to operate with different carrier powers, measurement of each parameter of the transmitter shall be performed at the highest power level in each band at which the interrogator is intended to operate.

If a family of equipment has alternative output power levels provided by the use of separate power modules or add-on stages, then each module or add-on stage shall be tested in combination with the equipment. The necessary number of samples and additional tests can be proposed by the provider and shall be agreed by the test laboratory based on the requirements of clause 5.4.3.

To simplify and harmonize the testing procedures between the different testing laboratories, measurements shall be performed according to the present document on samples of equipment as defined in clause 5.4.3. These clauses are intended to give confidence that the requirements set out in the present document have been met without the necessity of performing the full measurements at all frequencies.

5.4.2 Choice of model for testing

The provider shall supply one or more samples of the equipment, as appropriate, for testing.

If an equipment has several optional features considered not to affect the RF parameters then tests need only be performed on the equipment configured with that combination of features considered to be the most complex, as proposed by the provider and agreed by the test laboratory.

In the case of equipment without a 50 Ω external antenna connector, see clauses 5.4.4 to 5.4.6.

5.4.3 Provisions of samples for testing

Interrogators shall be submitted for test such that they may be configured to operate on each of the four high power channels within the relevant band(s) as specified in figures 3 and 4. It is only necessary for one sample of equipment to be tested.

The provider shall supply a quantity of at least 3 pre-programmed tags with each interrogator that is submitted for test.

The provider shall make available technical documentation and operating manuals, sufficient to allow testing to be performed. The test equipment used, together with relevant settings selected for the test, shall be recorded in the test report.

5.4.4 Equipment without an internal permanent or temporary antenna connector

The fact that use has been made of the internal antenna connection, or of a temporary connection, to facilitate measurements shall be recorded in the test report.

No connection shall be made to any internal permanent or temporary antenna connector during the performance of radiated emissions measurements, unless such action forms an essential part of the normal intended operation of the equipment as declared by the provider.

5.4.5 Test fixture

With equipment intended for use with an integral antenna, and not equipped with a 50 Ω RF output connector, the provider may supply a test fixture. This test fixture is a radio frequency coupling device for substituting the integral antenna with a 50 Ω radio frequency terminal at the working frequencies of the equipment under test. This allows certain measurements to be performed using conducted measurement methods. However, only relative measurements may be made. In addition, the test fixture shall provide, where applicable:

- 1) a connection to an external power supply;
- 2) a connection to a data interface.

The performance characteristics of the test fixture shall conform to the following basic parameters:

- 1) the circuitry associated with the RF coupling shall contain no active or non-linear devices;
- 2) the coupling loss shall not influence the measuring results;

- 3) the coupling loss shall be independent of the position of the test fixture and be unaffected by the proximity of surrounding objects or people;
- 4) the coupling loss shall be reproducible when the equipment under test is removed and replaced;
- 5) the coupling loss shall remain substantially constant when the environmental conditions are varied.

5.4.6 Submission of additional equipment with a temporary antenna connector

The provider may submit one set of equipment with the normal antenna connected, to enable the radiated measurements to be made. The provider shall attend the test laboratory at the conclusion of the radiated measurements, to disconnect the antenna and fit the temporary connector. The testing laboratory staff shall not connect or disconnect any temporary antenna connector.

Alternatively, the provider may submit two sets of equipment to the test laboratory, one fitted with a temporary antenna connector with the antenna disconnected and the other with the antenna connected. Equipment shall be used for the appropriate tests. The provider shall declare that the two sets of equipment are identical in all other respects.

5.4.7 Channel range

When submitting equipment for testing, the provider shall state the frequencies of the band(s) and channels on which the interrogator will operate. The provider shall also confirm that the interrogator shall operate on each of the declared channels without any change to the circuit or trimming of discrete components.

Trimming is an act by which the value (in this case relating to frequency) of a component is changed within the circuit. This act may include the physical alteration, substitution (by components of similar size and type) or activation/de-activation (via the setting of soldered bridges) of components.

5.4.8 Adjustable carrier levels

Where the interrogator is designed with an adjustable carrier, then all transmitter parameters shall be measured using the highest power level. The equipment shall then be set to the lowest carrier power setting and the measurements for spurious emissions shall be repeated.

5.4.9 Test mode

The interrogator shall include a suitable test mode to permit testing of the parameters defined in clauses 5.5 and 5.6. The test mode shall be readily controlled by means, for example, of an external PC or terminal unit.

The test mode shall include the features listed below:

- 1) It shall be possible to set the interrogator to transmit a continuously un-modulated carrier on any one of the declared channels of operation.
- 2) While the interrogator is transmitting on a pre-selected channel, it shall be possible to read and log the identity of any valid tags that are present in the interrogation field.
- 3) It shall be possible to cause the interrogator to transmit normal test signals continuously as defined in clause 5.3.2.2 at its maximum data rate as declared by the provider.
- 4) It shall be possible to configure a tag in a test mode such that, in the presence of an interrogation field, it transmits a continuous modulated response. Alternatively this requirement may be satisfied by a suitably configured test tag with an output that is representative of the production version.

The provider shall describe the method of achieving the four test conditions, which shall be described in the test report.

If an interrogator is intended to operate in the upper band in a country where ER-GSM has been allocated, then a means shall be provided to verify correct operation of the mitigation technique specified in clause 5.5.8.

5.5 Essential transmitter test suites

5.5.1 Measurement of frequency error for mains operated equipment

The measurements shall be made with the interrogator set to transmit a continuous un-modulated carrier and performed at each of the applicable frequencies specified in clause 4.2.3:

- a) Under normal test conditions:
 - The signal transmitted by the interrogator shall be connected by suitable means to the input of a frequency counter. The frequency displayed on the frequency counter shall be recorded.
- b) Under extreme test conditions:
 - For each combination of extreme voltage and temperature (see clause 5.1.3) the frequency displayed on the frequency counter shall be recorded. Four values shall be measured.

The results from the measurements shall be recorded in the test report.

5.5.2 Frequency stability under low voltage conditions

This test is for battery operated equipment.

- Step 1: An interrogator shall be set up to transmit a continuous un-modulated carrier. The signal transmitted by the interrogator shall be connected by suitable means to the input of a frequency counter.
- Step 2: The frequency displayed on the frequency counter shall be recorded.
- Step 3: The voltage from the test power source shall be reduced below the lower extreme test voltage limit towards zero. Whilst the voltage is reduced the carrier frequency shall be monitored.

The results from the measurements shall be recorded in the test report.

5.5.3 Effective Radiated power (e.r.p.)

5.5.3.1 General

This measurement shall apply to equipment with an integral antenna and to equipment supplied with a dedicated external antenna. Both radiated and conducted methods of measurement are permitted. Where the conducted method is used the conducted power shall be adjusted to take into account the gain of the antenna and be stated as e.r.p.

If the equipment is designed to operate with different carrier powers in different bands, the provider shall declare the rated power for each of the bands.

5.5.3.2 Method of measurement

5.5.3.2.1 General

These measurements shall be performed with a continuous un-modulated carrier at the highest power level in each band at which the transmitter is intended to operate. Alternatively the interrogator shall be set to the highest power level in the intended band and transmit repeatedly in its normal operational mode.

If an RFID system includes active components between the interrogator and its antenna, the interrogator and the active components shall be subjected to extreme temperature tests.

5.5.3.2.2 Radiated measurement

This measurement shall be carried out under normal test conditions only (see clause 5.1.1.1). The following steps shall be carried out in each of the bands specified in figures 1 and 2 in which the interrogator is designed to operate.

- Step 1: On a test site, selected from annex B, the interrogator shall be placed at the specified height on a support, as specified in annex B, and in the position closest to normal use as declared by the provider.
- Step 2: The interrogator shall be set to transmit continuously, with an unmodulated carrier, on one of the high power channels in the selected band. Alternatively if the interrogator is tested in its normal operational mode, it shall transmit repeatedly on the selected channel in accordance with the normal test signals for data specified in clause 5.3.2.2. The measuring receiver shall be positioned in the far field as defined in annex B and tuned to the frequency of the transmission under test.
- Step 3: A test antenna shall be oriented initially for vertical polarization and shall be chosen to correspond to the carrier frequency of the interrogator. The output of the test antenna shall be connected to a measuring receiver.
- Step 4: The measuring receiver shall be set to the following values:
- a) Resolution bandwidth: 300 kHz.
 - b) Video bandwidth: Equal to the RBW.
 - c) Sweep Time: Auto.
 - d) Span: 1 MHz.
 - e) Trace mode: Max. hold sufficient to capture all emissions.
 - f) Detection mode: RMS.
- For measurements in the upper band of an interrogator in its normal operational mode, the RBW shall be set to 1 MHz.
- Step 5: The test antenna shall be raised and lowered through the specified heights until the maximum signal level is detected by the measuring receiver.
- Step 6: The interrogator shall then be rotated through 360 ° in the horizontal plane, until the maximum signal level is detected by the measuring receiver.
- Step 7: The test antenna shall be raised and lowered again through the specified heights until the maximum signal level is detected by the measuring receiver. The maximum signal level detected by the measuring receiver shall be noted.
- Step 8: The interrogator shall be replaced by a substitution antenna as defined in clause B.1.6. The substitution antenna shall be connected to a calibrated signal generator. The substitution antenna shall be orientated for vertical polarization and the length of the substitution antenna shall be adjusted to correspond to the frequency of transmission of the interrogator. If necessary, the setting of the input attenuator of the measuring receiver shall be adjusted in order to increase the sensitivity of the measuring receiver.
- Step 9: The test antenna shall be raised and lowered through the specified heights to ensure that the maximum signal is received.
- Step 10: The input signal to the substitution antenna shall be adjusted to give a level at the measuring receiver that is equal to the radiated power previously measured from the interrogator, corrected for any change to the setting of the input attenuator to the measuring receiver.
- Step 11: The input level to the substitution antenna shall be recorded as the power level, corrected for any change of input attenuator setting of the measuring receiver.
- Step 12: The measurement shall be repeated with the test antenna and the substitution antenna orientated for horizontal polarization.
- Step 13: The measure of the effective radiated power is the larger of the two levels recorded at the input to the substitution antenna, corrected if necessary for the gain of the substitution antenna.

- Step 14: With the interrogator fitted into a suitable test fixture, the relative change of the effective radiated power between normal and extreme test conditions (see clauses 5.1.1.1 and 5.1.1.2 applied simultaneously) shall be compared. Any increase in the radiated power under extreme test conditions shall not cause the level to exceed the limits specified in clause 4.3.3.

5.5.3.2.3 Conducted measurement

Where an interrogator is fitted with an external antenna connector it is permissible to measure the conducted power. In this case the provider shall declare the maximum gain and beam-width(s) of the external antenna(s) at the time that the equipment is presented for test. The following steps shall be carried out in each of the bands specified in figures 1 and 2 in which the interrogator is designed to operate.

- Step 1: The transmitter shall be configured to operate on one of the high power channels in the selected band and shall be connected to an artificial antenna (see clause 5.3.2.3). The carrier or mean power delivered to the artificial antenna shall be measured under normal test conditions (see clause 5.1.1.1).
- Step 2: The measurement shall be repeated under extreme test conditions (see clauses 5.1.1.2 and 5.1.2.3 applied simultaneously).
- Step 3: The recorded value shall be corrected for each of the antenna gains and be stated in e.r.p. To calculate the allowed conducted power with a circularly polarized antenna, formula (1) shall be used:

$$P_C = P_{erp} - G_{IC} + 5,15 + C_L \quad \text{dBm} \quad (1)$$

Where:

P_C = interrogator conducted transmit power in dBm;

G_{IC} = antenna gain of a circular antenna in dBic;

C_L = total cable loss in dB.

- Step 4: Where the interrogator switches between multiple transmitter outputs, the power level shall be measured at each output.

The results from the measurements shall be recorded in the test report.

5.5.4 Transmitter antenna beam-width

5.5.4.1 General

These measurements shall be performed with an un-modulated carrier at the highest power level in each band at which the transmitter is intended to operate. Alternatively the interrogator shall be set to the highest power level in the intended band and transmit repeatedly in its normal operational mode.

The measuring receiver shall be set up in accordance with the requirements of clause 5.3.2.6.

5.5.4.2 Radiated measurement

The following steps shall be carried out in each of the bands specified in figures 1 and 2 in which the interrogator is designed to operate.

- Step 1: On a test site, selected from annex B, the interrogator shall be placed at the specified height on a support, as specified in annex B, and in the position closest to normal use as declared by the provider.
- Step 2: A test antenna shall be oriented initially for vertical polarization and shall be chosen to correspond to the carrier frequency of the interrogator. The output of the test antenna shall be connected to a measuring receiver.

- Step 3: The interrogator shall be set to transmit continuously, without modulation, on one of the high power channels in the selected band. The measuring receiver shall be positioned in the far field as defined in annex B and tuned to the frequency of the transmission under test.
- Step 4: The test antenna shall be raised and lowered through the specified heights until the maximum signal level is detected by the measuring receiver.
- Step 5: The interrogator shall then be rotated through 360 ° in the horizontal plane, until the maximum signal level is detected by the measuring receiver.
- Step 6: The test antenna shall be raised and lowered again through the specified heights until the maximum signal level is detected by the measuring receiver. The maximum signal level detected by the measuring receiver shall be noted.
- Step 7: The antenna of the interrogator shall be rotated in the horizontal plane in both directions to positions where the signal at the measuring receiver is reduced by 3 dB. The total angle of rotation (which is the horizontal beam-width of the antenna) shall be recorded.

5.5.5 Transmitter spectrum mask

5.5.5.1 Method of measurement

The following steps shall be carried out in each of the bands specified in figures 1 and 2 in which the interrogator is designed to operate.

The RF output of the equipment shall be connected to a spectrum analyser via a 50 Ω connector. In the case of equipment with an integral antenna, the equipment shall be placed in the test fixture (see clause 5.4.5) and the test fixture shall be connected to the spectrum analyser. Measurements shall be made on the declared channels of operation of the interrogator on those channels requiring full tests as defined in figures 3 and 4.

- Step 1: The interrogator shall be operated at the carrier power measured under normal test conditions in clause 5.1.1.1. The attenuator shall be adjusted to give an appropriate display on the spectrum analyser screen.
- Step 2: The interrogator shall be configured to generate a succession of modulated transmit pulses. Each transmit pulse shall be modulated by the normal test signal (see clause 5.3.2.2). The length of each transmit pulse shall be not less than 10 ms and not greater than 50 ms. The interval between successive transmit pulses shall be not less than 1 ms and shall not exceed 10 ms.
- Step 3: The output power of the interrogator, with or without a test fixture, shall be measured using a spectrum analyser, which shall be set to the following values:
- a) Resolution bandwidth: 1 kHz.
 - b) Video bandwidth: Equal to the RBW.
 - c) Sweep Time: Auto.
 - d) Span: 1 MHz.
 - e) Trace mode: Max. hold sufficient to capture all emissions.
 - f) Detection mode: Average.
- Step 4: For frequencies inside $f_c \pm 500$ kHz in the lower band and for frequencies inside $f_c \pm 1\,000$ kHz in the upper band, the measured values are the absolute values. The absolute levels of RF power shall be compared to the spectrum mask at figures 5 and 6. (See notes 1 and 2).
- Step 5: Where the interrogator includes multiple transmitter outputs, all of the outputs shall be connected via a suitable combiner network to the spectrum analyser. With the interrogator set up as in step 1 and configured to transmit the test signal described in step 2 while in its operational mode, the spectrum mask shall be measured at the spectrum analyser. The measured values shall be adjusted to compensate for the attenuation of the combiners and compared to the spectrum mask at figures 5 and 6.

NOTE: If for any reason the spectrum is measured with a resolution bandwidth other than 1 kHz, the measured values may be converted to the absolute values using formula (2):

$$B = A + 10 \log \frac{1 \text{ kHz}}{BW_{MEASURED}} \quad (2)$$

Where:

A is the value at the measured resolution bandwidth;

B is the absolute value referred to a 1 kHz reference bandwidth; or

use the measured value, A, directly if the measured spectrum is a discrete spectral line (a discrete spectrum line is defined as a narrow peak with a level of at least 6 dB above the average level inside the measurement bandwidth).

5.5.6 Transmitter spurious emissions

5.5.6.1 Method of measurement

Spurious emissions shall be measured at frequencies outside $f_c \pm 500$ kHz for the lower band and frequencies outside $f_c \pm 1\,000$ kHz for the upper band, as specified in figures 10 and 11 below. The level of spurious emissions shall be measured as:

either:

- a) i) their power level in a specified load (conducted spurious emission); and
ii) their effective radiated power when radiated by the cabinet and structure of the equipment (cabinet radiation); or
- b) their effective radiated power when radiated by the cabinet and the integral antenna, in the case of equipment fitted with such an antenna and no external RF connector.

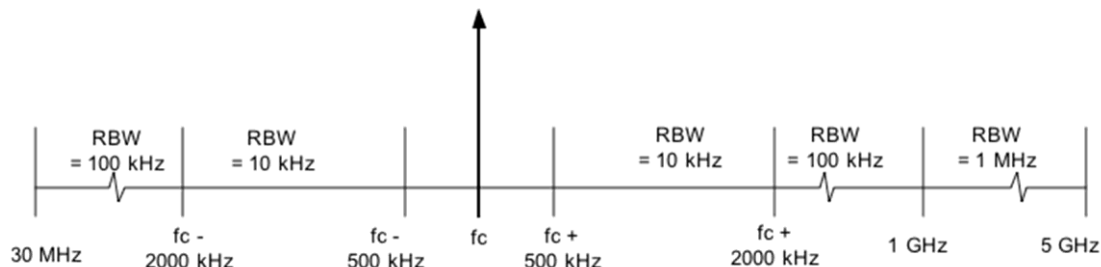

Figure 10: Resolution bandwidths for spurious emission in the lower band

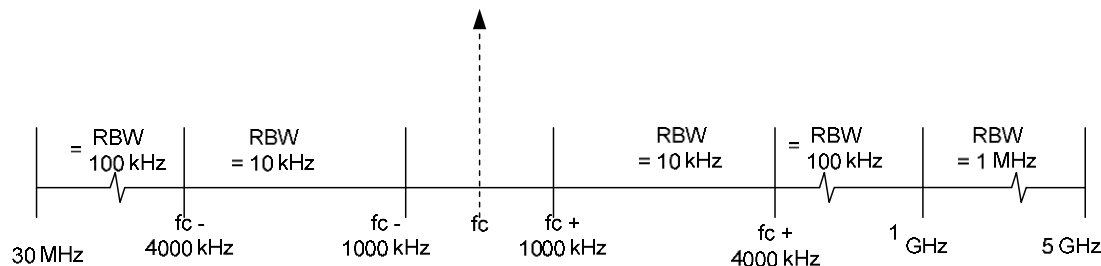

Figure 11: Resolution bandwidths for spurious emission in the upper band

The level of spurious emissions at any frequency shall not exceed the limits specified in table 2.

5.5.6.2 Method of measuring the spurious power level in a specified load, clause 5.5.6.1, a) i)

This method shall apply only to equipment with an external antenna connector.

Step 1: The interrogator shall be connected to a 50 Ω power attenuator. The output of the power attenuator shall be connected to a measuring receiver. The interrogator shall be set up to generate a succession of modulated transmit pulses as described in step 2 of clause 5.5.5.1.

In the event that the carrier signal from the interrogator is too high for the dynamic range of the measurement receiver, a notch filter may optionally be connected between the 50 Ω power attenuator and the measurement receiver to attenuate the carrier signal. This may be used for measurements at greater than 2 MHz from the carrier. The filter shall have a loss of less than 3 dB at ± 1 MHz from f_c .

Step 2: The measuring receiver, (see clause 5.3.2.6) shall be tuned over the frequency range of 30 MHz to 5 GHz. For each of the frequency ranges specified in figures 3 or 4 as applicable, the measuring receiver shall be set to the following values:

- a) Resolution bandwidth: In accordance with either figures 10 or 11 as applicable.
- b) Video bandwidth: Equal to the RBW.
- c) Sweep time: Auto.
- d) Span: As defined by the relevant frequency ranges in either figures 10 or 11 as applicable.
- e) Trace mode: Max. hold sufficient to capture emissions.
- f) Detection mode: Average.

Step 3: At each frequency at which a spurious component is detected, the power level shall be recorded as the conducted spurious emission level delivered into the specified load.

Step 4: The measurements shall be repeated with the interrogator on stand-by.

Step 5: The measurements shall be adjusted to give the output power of the interrogator with its declared antenna in e.r.p.

5.5.6.3 Method of measuring the spurious effective radiated power, clause 5.5.6.1 a) ii)

This method shall apply only to equipment with an external antenna connector.

Step 1: On a test site, selected from annex B, the interrogator shall be placed at the specified height on a non-conducting support and in the position closest to normal use as declared by the provider.

Step 2: The antenna connector of the interrogator shall be connected to an artificial antenna (see clause 5.3.2.3).

Step 3: A test antenna shall be orientated for vertical polarization and the length of the test antenna shall be chosen to correspond to the instantaneous frequency of the measuring receiver. The output of the test antenna shall be connected to a measuring receiver.

In the event that the carrier signal from the interrogator is too high for the dynamic range of the measurement receiver, a notch filter may optionally be connected between the test antenna and the measurement receiver to attenuate the carrier signal. This may be used for measurements at greater than 2 MHz from the carrier. The filter shall have a loss of less than 3 dB at ± 1 MHz from f_c .

Step 4: The interrogator shall be set up to generate a succession of modulated transmit pulses as described in step 2 of clause 5.5.5.1.

- Step 5: The measuring receiver (see clause 5.3.2.6) shall be tuned over the frequency range 30 MHz to 5 GHz, but excluding the frequencies inside $f_c \pm 500$ kHz for the lower band and for frequencies inside $f_c \pm 1\,000$ kHz for the upper band. The measurements shall be performed with the measuring receiver set to the following values:
- a) Resolution bandwidth: In accordance with either figures 10 or 11.
 - b) Video bandwidth: Equal to the RBW.
 - c) Sweep time: Auto.
 - d) Span: As defined by the relevant frequency ranges in either figures 10 or 11 as applicable.
 - e) Trace mode: Max. hold sufficient to capture emissions.
 - f) Detection mode: Average.
- Step 6: At each frequency at which a spurious component is detected, the test antenna shall be raised and lowered through the specified heights until a maximum signal level is detected by the measuring receiver.
- Step 7: The interrogator shall then be rotated through 360 ° in the horizontal plane, until the maximum signal level is detected by the measuring receiver and the test antenna height shall be adjusted again for maximum signal level.
- Step 8: The maximum signal level detected by the measuring receiver shall be noted.
- Step 9: The interrogator shall be replaced by a substitution antenna as defined in clauses B.1.4 and B.1.5.
- Step 10: The substitution antenna shall be orientated for vertical polarization and calibrated for the frequency of the spurious component detected.
- Step 11: The substitution antenna shall be connected to a calibrated signal generator.
- Step 12: The frequency of the calibrated signal generator shall be set in turn to the frequency of each of the spurious components detected. If necessary the input attenuator setting of the measuring receiver shall be adjusted in order to increase the sensitivity of the measuring receiver.
- Step 13: The test antenna shall be raised and lowered through the specified range of heights to ensure that the maximum signal is received. (When a test site according to clause B.1.2 is used, the height of the antenna need not be varied).
- Step 14: The input signal to the substitution antenna shall be adjusted to give a level at the measuring receiver, that is equal to the level noted while the spurious component was measured, corrected for any change to the setting of the input attenuator of the measuring receiver.
- Step 15: The input level to the substitution antenna shall be recorded as a power level, corrected for any change of input attenuator setting of the measuring receiver.
- Step 16: The measurement shall be repeated with the test antenna and the substitution antenna orientated for horizontal polarization.
- Step 17: The measure of the effective radiated power of the spurious components is the larger of the two power levels recorded for each spurious component at the input to the substitution antenna, corrected if necessary for the gain of the substitution antenna.
- Step 18: If applicable, the measurements shall be repeated with the interrogator on standby.

5.5.6.4 Method of measuring spurious effective radiated power, clause 5.5.6.1, b)

This method shall apply only to equipment without an external antenna connector. The method of measurement shall be performed according to clause 5.5.6.3, except that the interrogator output shall be connected to the integral antenna and not to an artificial antenna.

5.5.7 Transmission times

5.5.7.1 Method of measurement

This test shall apply to interrogators intended for operation in the lower band and is designed to verify that the interrogator shall transmit no longer than is necessary to perform the intended operation.

- Step 1: On a test site, selected from annex B, the equipment shall be placed at the specified height on a non-conducting support and in the position closest to normal use as declared by the provider. The interrogator shall be configured to operate on one of the high power channels shown in figure 1. A small quantity of tags (typically up to 3) shall be positioned within the interrogation field of the interrogator.
- Step 2: A probe shall be positioned close to the antenna of the interrogator and arranged such that it will trigger a digital storage oscilloscope.
- Step 3: The interrogator shall initiate an interrogation sequence and the trace generated by the transmission shall be recorded on the digital storage scope. The length of the transmission shall be measured.
- Step 4: The interrogator shall then be configured to demonstrate reading an unlimited number of tags in the interrogation field. This may be achieved either by setting the interrogator to its "global scroll" mode with a single tag in the field or by replacing the tags with a test fixture that simulates an infinite number of tags.
- Step 5: The transmission from the interrogator shall be monitored on a digital storage oscilloscope using a probe positioned close to the antenna of the interrogator.
- Step 6: The maximum length of continuous transmission and the interval between repeated transmissions recorded on the digital storage oscilloscope shall comply with the permitted limits.

5.5.8 Mitigation using DAA

5.5.8.1 Set-up for tests

For the purposes of this clause the following meanings shall apply:

- ER-GSM refers to the operation of railway GSM equipment in the extended band 918 MHz to 921 MHz. Note that an ER-GSM receiver covers the full frequency range 918 MHz to 921 MHz.
- R-GSM refers to the operation of railway GSM equipment in the band 921 MHz to 925 MHz.
- GSM-R is the collective term for railway GSM equipment operational in the band 918 MHz to 925 MHz.

Diagrams of the set-up to perform the tests are shown in figures 12 and 13 below. Where interrogators handle both the detection of the GSM-R signals and transmissions to the tags, the diagram in figure 12 should be used. It is irrelevant whether detection of the response from the tags is on the same port or a separate port.

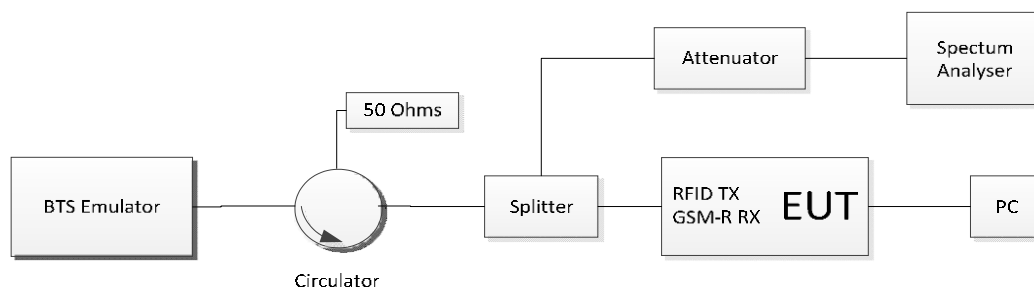

Figure 12: Set-up of equipment for mitigation test using splitter

Some interrogators may use a separate antenna to detect the GSM-R BCCH. Where this applies, the BTS emulator shall be connected directly to the input for the GSM signal on the GSM-R receiver. The port for transmissions by the interrogator to the RFID antenna shall be connected via the attenuator to the spectrum analyser. It is irrelevant whether detection of the response from the tags is on the same port or a separate port. This is illustrated in figure 13 below.

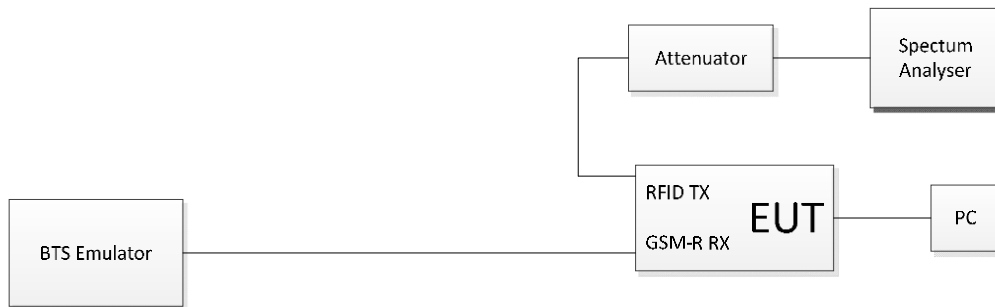

Figure 13: Set-up of equipment for mitigation test

Simulation of the BTS for GSM-R shall be by means of a Universal Radio Communications Tester or equivalent GSM-R emulator. The equipment should be configured to transmit a BCCH signal at selected frequencies within the bands specified in either clause 5.5.8.2 or clause 5.5.8.3. The BCCH shall contain SYSTEM INFORMATION 1, which shall include the Cell Channel Description giving details of any TCH channels and BTS operating in the ER-GSM band (see IEC 60489-3 [i.4]).

The GSM-R emulator shall be configured to transmit on a channel as specified in either Method 1 or Method 2 as appropriate. It shall include the information in its BCCH as specified in the following four scenarios.

- 1) Channel 941 (centre frequency of 918,4 MHz) included in ARFCN list.
- 2) Channel 948 (centre frequency of 919,8 MHz) included in ARFCN list.
- 3) Both channels 941 and 948 included in ARFCN list.
- 4) An ER-GSM BTS transmitting on channel 944 (centre frequency of 919,0 MHz) in the ARFCN list.

For all tests in clause 5.5.8 the RBW of the measuring receiver shall be set to 1 MHz.

5.5.8.2 Tests for Mitigation Method 1

These tests shall be performed using an ER-GSM receiver capable of receiving BTS transmissions across the frequency range 918 MHz to 925 MHz. The tests are designed to demonstrate that the interrogator complies with the mitigation technique described in clause C.6.

With the equipment connected in accordance with either figure 12 or figure 13, the following tests shall be performed:

Test 1 Operation with channel 941 (918,4 MHz) in the ARFCN list

The purpose of this test is to confirm that the interrogator is able to detect and decode a BCCH signal at levels down to -98 dBm. Furthermore the test will verify that, where the ER-GSM channel is within 700 kHz of the centre frequency of transmission of the interrogator (918,7 MHz), it will cease to transmit at this frequency.

Step 1: The interrogator shall be configured to transmit at 918,7 MHz.

Step 2: The interrogator shall be switched on and, after initialization, a check shall be made that the interrogator transmits at 918,7 MHz.

Step 3: The interrogator shall be switched off.

Step 4: The GSM-R emulator shall be configured to transmit a BCCH on a channel within the band 918 MHz to 925 MHz. The BCCH shall include channel 941 in its ARFCN list. The output from the GSM-R emulator shall be adjusted to give a signal level at the input to the ER-GSM receiver of -98 dBm assuming a 0 dBd antenna gain.

- Step 5: The interrogator shall be switched on and a check shall be made that the interrogator has ceased to transmit.
- Step 6: Without changing the settings of the GSM-R emulator, the interrogator shall be configured to transmit at 919,9 MHz.
- Step 7: A check shall be made to verify that the interrogator transmits at 919,9 MHz.

Test 2 Operation with channel 948 (919,8 MHz) in the BCCH ARCFN list

This test is identical to test 1 except that it confirms correct operation of the interrogator at a transmit frequency of 919,9 MHz.

- Step1: The interrogator shall be configured to transmit at 919,9 MHz.
- Step 2: The interrogator shall be switched on and, after initialization, a check shall be made that the interrogator transmits at 919,9 MHz.
- Step 3: The interrogator shall be switched off.
- Step 4: The GSM-R emulator shall be configured to transmit a BCCH on a channel within the band 918 MHz to 925 MHz, The BCCH shall include channel 948 in its ARCFN list. The output from the GSM-R emulator shall be adjusted to give a signal level at the input to the ER-GSM receiver of -98 dBm assuming a 0 dBd antenna gain.
- Step 5: The interrogator shall be switched on and, after initialization, a check shall be made that the interrogator does not transmit at 919,9 MHz.
- Step 6: Without changing the settings of the GSM-R emulator, the interrogator shall be configured to transmit at 918,7 MHz.
- Step 7: A check shall be made to verify that the interrogator transmits at 918,7 MHz.

Test 3 Operation with both channel 941 and channel 948 in the BCCH ARCFN list

The purpose of this test is to verify that, where the ER-GSM channels are within 700 kHz of either centre frequency of transmission of the interrogator (918,7 MHz or 919,9 MHz), it will cease all transmission.

- Step1: The interrogator shall be configured to transmit at both 918,7 MHz and 919,9 MHz.
- Step 2: The interrogator shall be switched on and, after initialization, a check shall be made that the interrogator is able to transmit at either 918,7 MHz or 919,9 MHz.
- Step 3: The GSM-R emulator shall be configured to transmit a BCCH signal on a channel within the band 915 MHz to 925 MHz, The BCCH shall include both channels 941 and 948 in its ARCFN list. The output from the GSM-R emulator shall be adjusted to give a signal level at the input to the ER-GSM receiver of -98 dBm assuming a 0 dBd antenna gain.
- Step 4: The interrogator shall be switched on and, after initialization, a check shall be made to ensure that the interrogator does not transmit at either frequency.

5.5.8.3 Tests for Mitigation Method 2

These tests shall be performed in situations where an ER-GSM receiver is unavailable and an R-GSM receiver is used to implement the mitigation technique described in clause C.7. The R-GSM receiver shall be capable of receiving BTS transmissions across the frequency range 921 MHz to 925 MHz. The tests are designed to demonstrate that in the event that ER-GSM is deployed at some point in the future, the mitigation technique will still ensure that ER-GSM is protected.

With the equipment connected in accordance with either figure 12 or figure 13, the following tests shall be performed.

Test 1 Operation with channel 941 (918,4 MHz) in the ARCFN list

The purpose of this test is to confirm that the interrogator is able to detect and decode a R-GSM BCCH at levels down to -98 dBm. Furthermore the test will verify that, where an ER-GSM channel is within 700 kHz of the centre frequency of transmission of the interrogator (918,7 MHz), it will cease to transmit at this frequency.

- Step 1: The interrogator shall be configured to transmit at 918,7 MHz.
- Step 2: The interrogator shall be switched on and, after initialization, a check shall be made that the interrogator transmits at 918,7 MHz.
- Step 3: The interrogator shall be switched off.
- Step 4: The GSM-R emulator shall be configured to transmit a BCCH on a channel within the band 921 MHz to 925 MHz, The BCCH shall include channel 941 in its ARCFN list. The output from the GSM-R emulator shall be adjusted to give a signal level at the input to the R-GSM receiver of -98 dBm assuming a 0 dBd antenna gain.
- Step 5: The interrogator shall be switched on and a check shall be made that the interrogator has ceased to transmit.
- Step 6: Without changing the settings of the GSM-R emulator, the interrogator shall be configured to transmit at 919,9 MHz.
- Step 7: A check shall be made to verify that the interrogator transmits at 919,9 MHz.

Test 2 Operation with channel 948 (919,8 MHz) in the ARCFN list

This test is identical to the test 1 except that it confirms correct operation of the interrogator at a transmit frequency of 919,9 MHz.

- Step 1: The interrogator shall be configured to transmit at 919,9 MHz.
- Step 2: The interrogator shall be switched on and, after initialization, a check shall be made that the interrogator transmits at 919,9 MHz.
- Step 3: The interrogator shall be switched off.
- Step 4: The GSM-R emulator shall be configured to transmit a BCCH on a channel within the band 921 MHz to 925 MHz, The BCCH shall include channel 948 in its ARCFN list. The output from the GSM-R emulator shall be adjusted to give a signal level at the input to the R-GSM receiver of -98 dBm assuming a 0 dBd antenna gain.
- Step 5: The interrogator shall be switched on and, after initialization, a check shall be made that the interrogator does not transmit at 919,9 MHz.
- Step 6: Without changing the settings of the GSM-R emulator, the interrogator shall be configured to transmit at 918,7 MHz.
- Step 7: A check shall be made to verify that the interrogator transmits at 918,7 MHz.

Test 3 Operation with both channel 941 and channel 948 in the ARCFN list

The purpose of this test is to verify that, where the ER-GSM channels are within 700 kHz of either centre frequency of transmission of the interrogator (918,7 MHz or 919,9 MHz), it will cease all transmission.

- Step 1: The interrogator shall be configured to transmit at both 918,7 MHz and 919,9 MHz.
- Step 2: The interrogator shall be switched on and, after initialization, a check shall be made that the interrogator is able to transmit at either 918,7 MHz or 919,9 MHz.

- Step 3: The GSM-R emulator shall be configured to transmit a BCCH on a channel within the band 921 MHz to 925 MHz, The BCCH shall include both channels 941 and 948 in its ARFCN list. The output from the GSM-R emulator shall be adjusted to give a signal level at the input to the R-GSM receiver of -98 dBm assuming a 0 dBd antenna gain.
- Step 4: The interrogator shall be switched on and, after initialization, a check shall be made to ensure that the interrogator does not transmit at either frequency.
- Test 4: A BTS on channel 944 (centre frequency of 919,0 MHz) in the ARFCN list**
- The purpose of this test is to demonstrate that, if at some point in the future a BTS is assigned to the ER-GSM band, its presence will be detected and the interrogator will be prevented from transmitting on both of its high power channels in the ER-GSM band.
- Step 1: The interrogator shall be configured to transmit at both 918,7 MHz and 919,9 MHz.
- Step 2: The interrogator shall be switched off.
- Step 3: The GSM-R emulator shall be configured to transmit a BCCH signal on a channel within the band 921 MHz to 925 MHz. The BCCH signal shall include a BTS on channel 944 (919,0 MHz) in the ARFCN list. The output from the GSM-R emulator shall be adjusted to give a signal level at the input to the R-GSM receiver of -98 dBm assuming a 0 dBd antenna gain.
- Step 4: The interrogator shall be switched on and, after initialization, a check shall be made to ensure that the interrogator does not transmit at either 918,7 MHz or 919,9 MHz.

The results of the tests shall be recorded in the test report.

5.6 Essential receiver test suites

5.6.1 Adjacent channel selectivity

5.6.1.1 General

This measurement is required to ensure satisfactory operation of equipment in accordance with the band plan. Two alternative methods are specified, which lead to different results. This provides the flexibility to measure interrogators with both high and low gain antennas. The method of measuring radiated signals requires correction as specified in Step 10 of clause 5.6.1.2.

Where the interrogator is not fitted with an external antenna connector, the measurement shall be made as described in clause 5.6.1.2.

5.6.1.2 Method of measuring radiated signals

- Step 1: An interrogator shall be set up to operate at its maximum output power on a known channel in the lower band either in an anechoic chamber or on an open air test site as specified in annex B. The offset frequency shall be set to approximately 300 kHz. The interrogator shall be connected to an antenna with combined Tx and Rx functionality.
- Step 2: A tag shall be selected with an antenna gain of greater than 0 dBi and a sensitivity of better than -15 dBm. With the tag in its preferred orientation it shall be moved slowly towards the interrogator in the direction of maximum gain of its antenna to a point where the tag is just identified. The distance d between the antenna of the interrogator and the tag shall be measured. If the distance between the tag and the interrogator is too great to fit within the anechoic chamber, an attenuator may be inserted between the interrogator and its antenna.
- Step 3: The tag shall then be moved to a new position that is at a distance of $0,7 d$ from the interrogator in the direction of maximum gain of its antenna.
- Step 4: A signal generator fitted with a horn antenna shall be set up in accordance with figure 14 and its transmission directed at the antenna of the interrogator.

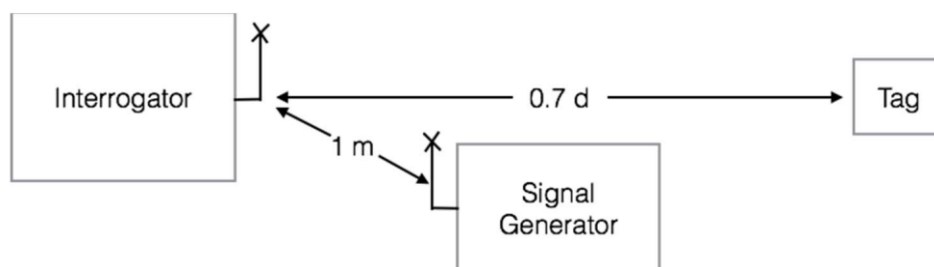

Figure 14: Radiated test set up for adjacent channel selectivity

- Step 5: The signal generator shall be adjusted to radiate a signal at a test frequency that lies at the mid-point of the upper adjacent channel. The signal shall be an AM modulated sine wave to a depth of 80 % at a frequency of 40 kHz.
- Step 6: The level of the signal generator shall be increased until the interrogator just ceases to identify the tag. The level of the signal generator shall then be reduced in 1 dB steps until the interrogator just identifies the tag again.
- Step 7: The interrogator shall be removed and replaced by a measurement antenna connected to a measurement receiver set to a resolution bandwidth of 100 kHz. The level of signal from the signal generator received at the measurement receiver shall be recorded.
- Step 8: The measurement shall be repeated for the lower adjacent channel.
- Step 9: Steps 1 to 8 shall be repeated for the upper band using an offset frequency of approximately 600 kHz.
- Step 10: The absolute levels of the signals received by the measurement receiver from the signal generator shall be corrected using formula 3.

$$S_{ACH} = P_{MR} - G_{MR} \quad (3)$$

Where:

S_{ACH} is the adjacent channel selectivity in dBm.

P_{MR} is the signal strength received at the measurement receiver.

G_{MR} is the antenna gain of the measurement receiver antenna in dBi;

The corrected power level for each measurement shall be not less than the limit specified in clause 4.4.1.3.

5.6.1.3 Conducted method of measurement

Where the interrogator is fitted with an external antenna connector, the measurement may be made using a modified tag that provides a hard-wire connection.

- Step 1: An interrogator shall be configured to operate in the lower band in accordance with figure 15 below. The offset frequency shall be set to approximately 300 kHz.

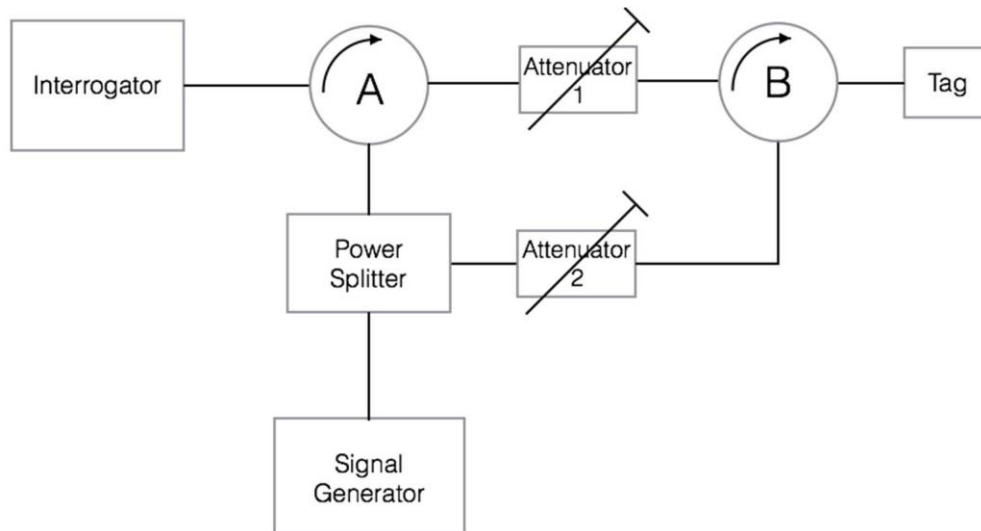

Figure 15: Conducted test set up for adjacent channel selectivity

- Step 2: To check that the tag is not activated by the interrogator via attenuator 2, attenuator 1 shall be removed from the circuit. The open port of circulators A and B shall each be terminated by a 50 Ohm load resistor. With the signal generator switched off, the interrogator shall be switched on at its maximum output power on a known channel in the lower band. Attenuator 2 shall be increased until the interrogator just ceases to identify the tag. The value of attenuator 2 shall be noted. For the remainder of the test attenuator 2 shall not be reduced below this figure.
- Step 3: The 50 Ohm load resistors shall be removed from circulators A and B and replaced by attenuator 1. With the signal generator switched off, the interrogator shall be switched on again at its maximum output power. Attenuator 1 shall be increased until it is just possible for the interrogator to read the tag. The setting of the attenuator 1 shall then be reduced by 10 dB to ensure that the tag remains fully activated.
- Step 4: With the signal generator switched off, attenuator 2 shall be increased until the interrogator is just able to identify the tag. Attenuator 2 shall then be reduced by 3 dB to ensure that the interrogator receives an acceptable signal level from the tag.
- Step 5: The signal generator shall be adjusted to generate a signal at a test frequency that lies at the mid-point of the upper adjacent channel. The signal shall be an AM sine wave modulated to a depth of 80 % at a frequency of 40 kHz.
- Step 6: The level of the signal generator shall be increased until the interrogator just ceases to identify the tag. The level of the signal generator shall then be reduced in 1 dB steps until the interrogator just identifies the tag again. The level of signal from the signal generator shall be recorded.
- Step 7: The level of signal from the signal generator shall be adjusted to compensate for the losses in both circulator A and the power splitter to give the corrected signal received in dBm at the input of the interrogator.
- Step 8: The measurement shall be repeated for the lower adjacent channel.
- Step 9: Steps 1 to 8 shall be repeated on the upper band using an offset frequency of approximately 600 kHz.
- Step 10: The absolute level of the corrected signals from the signal generator referred to the input of the interrogator in dBm shall be not less than the limit specified in clause 4.4.1.3.

The results shall be recorded in the test report.

5.6.2 Blocking or desensitization

5.6.2.1 General

This measurement is required to ensure satisfactory operation of equipment in accordance with the band plan. Two alternative methods are specified, which lead to different results. This provides the flexibility to measure interrogators with both high and low gain antennas. The method of measuring radiated signals requires correction as specified in Step 10.

Where the interrogator is not fitted with an external antenna connector, the measurement shall be made as described in clause 5.6.2.2.

5.6.2.2 Method of measuring radiated signals

- Step 1: This test may be performed either in an anechoic chamber or on an open-air test site as specified in annex B. An interrogator shall be set up to operate on a known high power channel in the lower band using an offset frequency of approximately 300 kHz in accordance with figure 14.
- Step 2: A tag shall be selected with an antenna gain of greater than 0 dBi and a sensitivity of better than -15 dBm. The tag, in its preferred orientation, shall be moved slowly towards the interrogator in the direction of maximum gain of its antenna to a point where it is just identified. The distance d between the antenna of the interrogator and the tag shall be measured. If the distance between the tag and the interrogator is too great to fit within the anechoic chamber, an attenuator may be inserted between the interrogator and its antenna.
- Step 3: The tag shall then be moved to a new position that is at a distance of $0,7 \times d$ from the interrogator in the direction of maximum gain of its antenna.
- Step 4: A signal generator fitted with a horn antenna shall be set up in accordance with figure 14 and its transmission directed at the antenna of the interrogator.
- Step 5: The signal generator shall be adjusted to radiate an un-modulated signal at test frequencies of approximately 2 MHz, 5MHz and 10 MHz above the centre frequency of the interrogator.
- Step 6: At each test frequency the level of the signal generator shall be increased until the interrogator just ceases to identify the tag. The level of the signal generator shall then be reduced in 1 dB steps until the interrogator just identifies the tag again.
- Step 7: The interrogator shall be removed and replaced by a measurement antenna connected to a measuring receiver set to a resolution bandwidth of 100 kHz. At each test frequency the level of signal from the signal generator received at the measuring receiver shall be recorded.
- Step 8: The tests shall be repeated at approximately, -2 MHz, -5 MHz and -10 MHz from the carrier frequency of the interrogator.
- Step 9: Steps 2 to 8 shall be repeated in the upper band using an offset frequency of approximately 600 kHz.
- Step 10: The blocking or desensitization shall be recorded in the test report as the highest level in dBm at the input to the interrogator of the unwanted signal at which it is just possible to identify a tag.

The absolute levels of the signals received by the measurement receiver from the signal generator shall be corrected using formula (4).

$$S_{BL} = P_{MR} - G_{MR} \quad (4)$$

Where:

S_{BL} is the blocking level in dBm.

P_{MR} is the signal strength received at the measurement receiver.

G_{MR} is the antenna gain of the measurement receiver antenna in dBi.

The highest corrected power level in dBm referred to the input to the interrogator at which it is just possible to identify a tag shall be not less than the limit specified in clause 4.4.2.3.

5.6.2.3 Conducted method of measurement

Where the interrogator is fitted with an external antenna connector, the measurement may be made using a modified tag that provides a hard-wire connection.

- Step 1: An interrogator shall be set up to operate in the lower band using an offset frequency of approximately 300 kHz in accordance with figure 15 shown above.
- Step 2: To check that the tag is not activated by the interrogator via attenuator 2, attenuator 1 shall be removed from the circuit. The open port of circulators A and B shall each be terminated by a 50 Ohm load resistor. With the signal generator switched off, the interrogator shall be switched on at its maximum output power on a known channel in the lower band. Attenuator 2 shall be increased until the interrogator just ceases to identify the tag. The value of attenuator 2 shall be noted. For the remainder of the test attenuator 2 shall not be reduced below this figure.
- Step 3: The 50 Ohm load resistors shall be removed from circulators A and B and replaced by attenuator 1. With the signal generator switched off, the interrogator shall be switched on again at its maximum output power. Attenuator 1 shall be increased until it is just possible for the interrogator to read the tag. The setting of the attenuator 1 shall then be reduced by 10 dB to ensure that the tag remains fully activated.
- Step 4: With the signal generator switched off, attenuator 2 shall be increased until the interrogator is just able to identify the tag. Attenuator 2 shall then be reduced by 3 dB to ensure that the interrogator receives an acceptable signal level from the tag.
- Step 5: The signal generator shall be adjusted to produce an un-modulated signal at test frequencies of approximately 2 MHz, 5 MHz and 10 MHz above the carrier frequency of the interrogator.
- Step 6: At each test frequency the level of the signal generator shall be increased until the interrogator just ceases to identify the tag. The level of the signal generator shall then be reduced in 1 dB steps until the interrogator just identifies the tag again. The level of signals from the signal generator at which the interrogator just identifies the tag shall be recorded.
- Step 7: The tests shall be repeated at approximately -2 MHz, -5 MHz and -10 MHz from the centre frequency of the interrogator.
- Step 8: The recorded signals from the signal generator shall be corrected to compensate for any losses in both circulator A and in the power splitter to give the corrected signals received at the input to the interrogator.
- Step 9: Steps 1 to 8 shall be repeated for the upper band using an offset frequency of approximately 600 kHz.
- Step 10: At each test frequency the blocking or desensitization shall be recorded in the test report as the highest corrected level in dBm of the unwanted signal at which it is just possible to identify a tag. The corrected levels shall comply with the limits specified in clause 4.4.2.3.

5.7 Essential tag test suites

5.7.1 Tag radiated power (e.r.p.)

5.7.1.1 Method of measurement

These tests shall be performed only in the bands in which the tag is intended to operate.

The measurement shall be performed using an interrogator, or an equivalent test fixture, and antenna under the same set-up conditions as used for the measurement of effective radiated power in clause 5.5.3. The intentional emissions from the tag shall be measured as:

either:

- a) the power from a tag configured to emit an un-modulated sub-carrier; or
- b) the power from a tag configured to emit a continuous modulated response.

5.7.1.2 Method of measuring the power in an un-modulated sub-carrier, clause 5.7.1.1 a)

This method applies to tags that may be set to emit an un-modulated sub-carrier.

- Step 1: On a test site, selected from annex B, the interrogator shall be placed at the specified height on a non-conducting support and in the position closest to normal use as declared by the provider.
- Step 2: In each band at which the tag is capable of operating, the interrogator shall be set to transmit at a single carrier frequency "fc" on a high power channel as determined by the test house. The interrogator shall provide an initial "wake up signal" to activate the tag followed by a continuous carrier at a power level of 2 W e.r.p.
- Step 3: The tag under test shall be positioned in free space at a distance of 20 cm from the antenna of the interrogator in its direction of maximum gain and in an orientation that provides optimum coupling with the transmitted signal. For the lower band the tag shall be configured to emit an un-modulated sub-carrier at an approximate frequency of $f_c \pm 300$ kHz, or such other frequency as declared by the manufacturer, (see figure 8). For the upper band the tag shall be configured to emit an un-modulated sub-carrier at an approximate frequency of $f_c \pm 600$ kHz, or such other frequency as declared by the manufacturer, (see figure 9).
- Step 4: The measurement shall be carried out using a measuring receiver set to the following values:
 - a) Resolution bandwidth: 1 kHz;
 - b) Video bandwidth: Equal to the RBW;
 - c) Sweep time: Auto;
 - d) Span: 1 MHz;
 - e) Detection mode: Average.
- Step 5: A measurement antenna shall be positioned at a distance of 1 m from the tag in the direction of maximum gain of the antenna of the interrogator. The measurement antenna shall be connected to the measuring receiver. The measurement antenna shall be orientated to obtain maximum signal. A diagram of the test configuration is shown in figure 16.

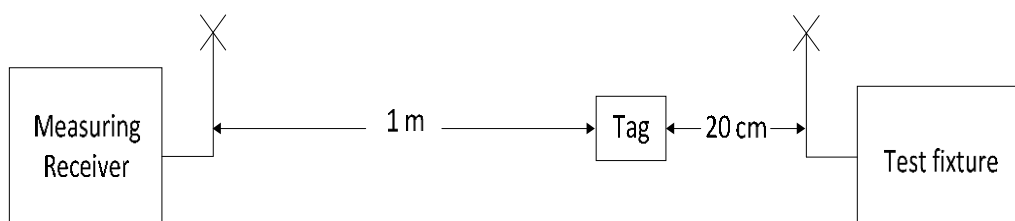

Figure 16: Measurement of tag emissions

- Step 6: The measuring receiver shall be tuned to the frequency of the lower sub-carrier of the tag and the level of the combined emissions from both the tag and interrogator shall be recorded. The same procedure shall be repeated for the upper sub-carrier.

- Step 7: Without moving the test antenna and the interrogator, the tag shall be removed from the proximity of the test area. The measuring receiver shall be tuned to the same frequencies as in step 6 and the levels of the emissions from the interrogator shall be recorded.
- Step 8: The power emitted by the tag shall be determined by deducting the levels in μW recorded in step 7 from the corresponding levels recorded in step 6. The maximum value of the upper and lower sub-carrier frequencies shall be recorded as the emitted power.
- Step 9: In normal operation the emissions from the tag in the lower band are spread across 300 kHz in the sidebands on both sides of f_c . For the upper band the emissions from the tag are spread across 600 kHz in the sidebands on both sides of f_c . (See figures 8 and 9) The power emitted shall be calculated as power spectrum density in 100 kHz using formula (5):

$$= P_c + 10 \frac{A}{BW} \quad (5)$$

Where:

P_c is the radiated power of the unmodulated sub-carrier from the tag;

A is the absolute value of the power spectrum density referred to a 100 kHz reference bandwidth;

BW is the bandwidth occupied by the tag response in a single sideband as defined in step 9.

5.7.1.3 Method of measuring the power in a modulated sub-carrier, clause 5.7.1.1 b)

This method applies to tags that are able only to emit a modulated sub-carrier.

- Step 1: On a test site, selected from annex B, the interrogator shall be placed at the specified height on a non-conducting support and in the position closest to normal use as declared by the provider.
- Step 2: In each band in which the tag is capable of operating the interrogatory shall be set to transmit at a single carrier frequency " f_c " on a high power channel as determined by the test house. The interrogator shall provide an initial "wake up command" to activate the tag followed by a continuous carrier at a power level of 2 W e.r.p.
- Step 3: The tag under test shall be positioned in free space at a distance of 20 cm from the antenna of the interrogator in its direction of maximum gain and in an orientation that provides optimum coupling with the transmitted signal. The tag shall be configured to emit a continuous modulated response as described in clause 5.4.9. For the lower band this response shall be centred at an approximate offset frequency of $f_c \pm 300$ kHz, or such other frequency as declared by the manufacturer. For the upper band this response shall be centred at an approximate offset frequency of $f_c \pm 600$ kHz, or such other frequency as declared by the manufacturer.
- Step 4: The measurement shall be carried out using a measuring receiver set to the following values:
- a) Resolution bandwidth: 1 kHz;
 - b) Video bandwidth: Equal to the RBW;
 - c) Sweep time: Auto;
 - d) Span: 1 MHz;
 - e) Detection mode: Average.
- Step 5: A test antenna shall be positioned at a distance of 1 m from the tag in the direction of maximum gain of the antenna of the interrogator. The test antenna shall be connected to the measurement receiver. The measurement antenna shall be orientated to obtain maximum signal. A diagram of the test configuration is shown in figure 16.
- Step 6: For the lower band a plot of the combined emissions from the tag and interrogator shall be recorded in increments of 3 kHz across the frequency range $f_c - 400$ kHz to $f_c - 100$ kHz. For the upper band the combined emissions from the tag and interrogator shall be recorded in increments of 3 kHz across the frequency range $f_c - 800$ kHz to $f_c - 200$ kHz.

- Step 7: Without moving the test antenna and the interrogator, the tag shall be removed from the proximity of the test area. A plot shall be made of the emissions from the interrogator in increments of 3 kHz over the same frequency range.
- Step 8: The power emitted by the tag shall be determined by deducting the levels in μW recorded in step 7 from levels recorded in step 6 for each increment of 3 kHz and summing the results to give the total power emitted by the tag.
- Step 9: Steps 6 to 8 shall be repeated across the upper side-band. For the lower band this shall cover the range $f_c + 400$ kHz to $f_c + 100$ kHz. For the upper band this shall cover the range $f_c + 800$ kHz to $f_c + 200$ kHz. The higher of the values obtained in the lower and upper sidebands shall be recorded as the radiated power of the tag.
- Step 10: The radiated power of the tag as derived in step 9 may be referred to a 100 kHz bandwidth using formula (6):

$$P_c = A + 10 \frac{P_c}{BW} \quad (6)$$

Where:

P_c is the radiated power of the tag;

A is the absolute value of the power spectrum density referred to a 100 kHz reference bandwidth;

BW is the bandwidth occupied by the tag response in a single sideband as defined in step 9.

The results shall be recorded in the test report.

5.7.2 Unwanted emissions

5.7.2.1 Method of measurement

The measurement shall be performed using an interrogator, or equivalent test fixture, and antenna under the same set-up conditions as used for the measurement of effective radiated power in clause 5.5.3.

In the event that the carrier signal from the interrogator is too high for the dynamic range of the measurement receiver, a notch filter may optionally be connected between the measurement antenna and the measurement receiver to attenuate the carrier signal. This may be used for measurements at greater than 2 MHz from the carrier. The filter shall have a loss of less than 3 dB at ± 1 MHz from f_c .

- Step 1: On a test site, selected from annex B, the interrogator shall be placed at the specified height on a non-conducting support and in the position closest to normal use as declared by the provider.
- Step 2: In each band at which the tag is capable of operating the interrogator shall be set to transmit at a single carrier frequency " f_c " on a high power channel as determined by the test house. The interrogator shall provide an initial "wake up response" to activate the tag followed by a continuous carrier at a power level of 2 W e.r.p.
- Step 3: The tag under test shall be positioned at a distance of 20 cm from the antenna of the interrogator in its direction of maximum gain and in an orientation that provides optimum coupling with the transmitted signal. The tag shall be configured to emit a continuous modulated response as described in clause 5.4.9 at an approximate offset frequency of either $f_c \pm 300$ kHz for the lower band or ± 600 kHz for the upper band or such other frequency as declared by the manufacturer.
- Step 4: The measurement shall be carried out using a measuring receiver set to the following values:
- Resolution bandwidth: In accordance with the figures 17 or 18 as applicable;
 - Video bandwidth: Equal to the RBW;
 - Sweep time: Auto;
 - Span: As defined by the relevant frequency ranges in figures 17 or 18 as applicable;

- e) Trace mode: Average;
 f) Detection mode: Average.

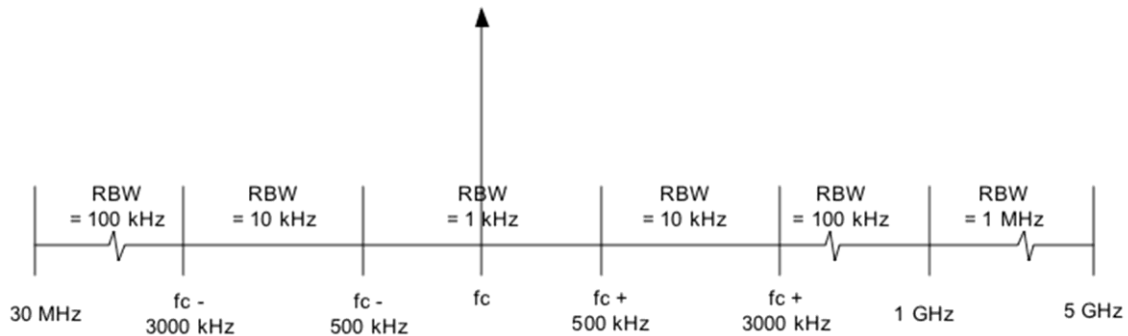

NOTE: See clause 5.7.1 for measurement of the intentional power radiated by tags.

Figure 17: Resolution bandwidths for tag emissions in the lower band

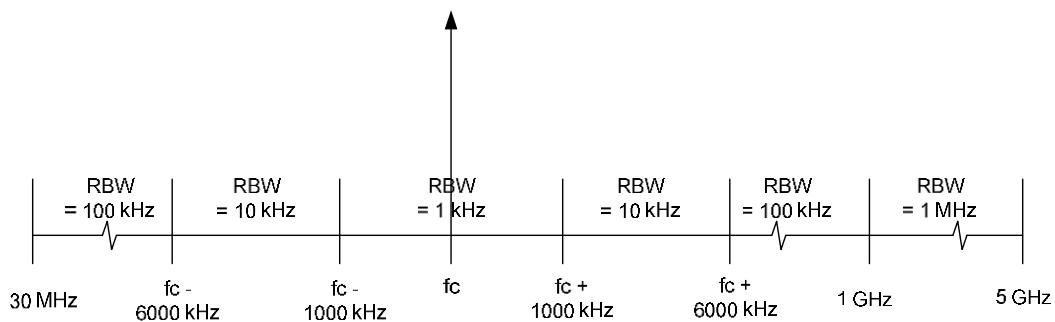

NOTE: See clause 5.7.1 for measurement of the intentional power radiated by tags.

Figure 18: Resolution bandwidths for tag emissions in the upper band

- Step 5: A test antenna shall be positioned at a distance of 1 m from the tag in the direction of maximum gain of the antenna of the interrogator. The test antenna shall be connected to the measuring receiver. The test antenna shall be orientated to obtain maximum signal. A diagram of the test configuration is shown in figure 16.
- Step 6: The measuring receiver shall be set to the resolution bandwidths specified in figures 17 or 18 as applicable, which are the same as the reference bandwidths. Alternatively a lower resolution bandwidth may be used to improve the measurement accuracy.
- Step 7: A plot of the combined emissions from both the tag and interrogator shall be recorded.
- Step 8: The tag shall be removed from the proximity of the test area. Without moving the test antenna and the interrogator a plot shall again be taken across the same frequency range.
- Step 9: Where the specified resolution bandwidths in figures 17 or 18 are used, the unwanted emissions from the tag shall be determined by deducting the levels in μW recorded in step 8 from levels recorded in the step 7.
- Step 10: At frequencies outside those measured in clause 5.7.1, the discrete spectral components within each reference band specified in figures 17 or 18 shall be recorded. The recorded values shall not exceed the limits specified for the operating mode in table 2.

Annex A (normative): Relationship between the present document and the essential requirements of Directive 2014/53/EU

The present document has been prepared under the Commission's standardisation request C(2015) 5376 final [i.10] to provide one voluntary means of conforming to the essential requirements of Directive 2014/53/EU on the harmonisation of the laws of the Member States relating to the making available on the market of radio equipment and repealing Directive 1999/5/EC [i.3].

Once the present document is cited in the Official Journal of the European Union under that Directive, compliance with the normative clauses of the present document given in table A.1 confers, within the limits of the scope of the present document, a presumption of conformity with the corresponding essential requirements of that Directive, and associated EFTA regulations.

Table A.1: Relationship between the present document and the essential requirements of Directive 2014/53/EU

Harmonised Standard ETSI EN 302 208				
The following requirements are relevant to the presumption of conformity under article 3.2 of Directive 2014/53/EU [i.3]				
Requirement			Requirement Conditionality	
No	Description	Reference: Clause No	U/C	Condition
1	Frequency error	4.3.1	C	Applies to interrogators
2	Frequency stability under low voltage conditions	4.3.2	C	Applies to battery powered interrogators
3	Effective radiated power	4.3.3	C	Applies to interrogators
4	Transmitter antenna beam-width	4.3.4	C	Applies to antennas [in both lower and upper bands]
5	Transmission spectrum masks	4.3.5	C	Applies to interrogators
6	Transmitter spurious emissions	4.3.6	C	Applies to interrogators
7	Transmission times	4.3.7	C	Applies to interrogators in the lower band
8	Mitigation using DAA	4.3.8	C	Applies to interrogators in the upper band
9	Receiver selectivity	4.4.1	C	Applies to interrogators
10	Receiver blocking	4.4.2	C	Applies to interrogators
11	Receiver spurious emissions	4.4.3	C	Applies to interrogators
12	Tag radiated power	4.5.1	C	Applies to tags
13	Tag unwanted emissions	4.5.2	C	Applies to tags

Key to columns:

Requirement:

No A unique identifier for one row of the table which may be used to identify a requirement.

Description A textual reference to the requirement.

Clause Number Identification of clause(s) defining the requirement in the present document unless another document is referenced explicitly.

Requirement Conditionality:

U/C Indicates whether the requirement shall be unconditionally applicable (U) or is conditional upon the manufacturer's claimed functionality of the equipment (C).

Condition Explains the conditions when the requirement shall or shall not be applicable for a requirement which is classified "conditional".

Presumption of conformity stays valid only as long as a reference to the present document is maintained in the list published in the Official Journal of the European Union. Users of the present document should consult frequently the latest list published in the Official Journal of the European Union.

Other Union legislation may be applicable to the product(s) falling within the scope of the present document.

Annex B (normative): Radiated measurement

B.1 Test sites and general arrangements for measurements involving the use of radiated fields

B.1.1 General

This annex is applicable to the assessment of data or equipment providing a specific response.

It covers test sites and methods to be used with integral antenna equipment or equipment having an antenna connector. This annex introduces three most commonly available test sites, an anechoic chamber, an anechoic chamber with a ground plane and an Open Area Test Site (OATS), which may be used for radiated tests. These test sites are generally referred to as free field test sites. Both absolute and relative measurements can be performed in these sites. Where absolute measurements are to be carried out, the chamber shall be verified. A detailed verification procedure shall be in accordance with ETSI TR 102 273 [1].

NOTE: To ensure reproducibility and tractability of radiated measurements only these test sites should be used in measurements in accordance with the present document.

B.1.2 Anechoic chamber

An anechoic chamber is an enclosure, usually shielded, whose internal walls, floor and ceiling are covered with radio absorbing material, normally of the pyramidal urethane foam type. The chamber usually contains an antenna support at one end and a turntable at the other. A typical anechoic chamber is shown in figure B.1.

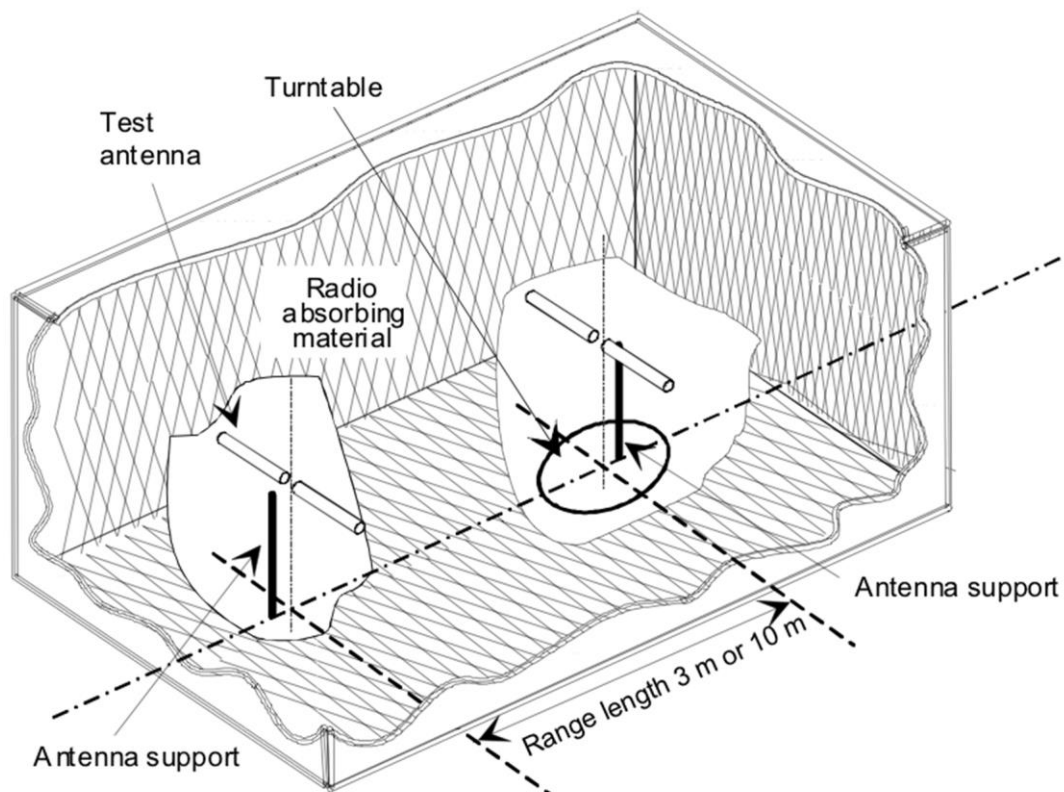

Figure B.1: A typical anechoic chamber

The chamber shielding and radio absorbing material work together to provide a controlled environment for testing purposes. This type of test chamber attempts to simulate free space conditions.

The shielding provides a test space, with reduced levels of interference from ambient signals and other outside effects, whilst the radio absorbing material minimizes unwanted reflections from the walls and ceiling which can influence the measurements. In practice it is relatively easy for shielding to provide high levels (80 dB to 140 dB) of ambient interference rejection, normally making ambient interference negligible.

A turntable is capable of rotation through 360 ° in the horizontal plane and it is used to support the test sample (EUT) at a suitable height (e.g. 1 m) above the ground plane. The chamber shall be large enough to allow the measuring distance of at least 3 m or $2(d_1+d_2)^2/\lambda$ (m), whichever is greater (see clause B.2.5). The distance used in actual measurements shall be recorded with the test results.

The anechoic chamber generally has several advantages over other test facilities. There is minimal ambient interference, minimal floor, ceiling and wall reflections and it is independent of the weather. It does however have some disadvantages, which include limited measuring distance and limited lower frequency usage due to the size of the pyramidal absorbers. To improve low frequency performance, a combination structure of ferrite tiles and urethane foam absorbers is commonly used.

All types of emission, sensitivity and immunity testing can be carried out within an anechoic chamber without limitation.

B.1.3 Anechoic chamber with a conductive ground plane

An anechoic chamber with a conductive ground plane is an enclosure, usually shielded, whose internal walls and ceiling are covered with radio absorbing material, normally of the pyramidal urethane foam type. The floor, which is metallic, is not covered and forms the ground plane. The chamber usually contains an antenna mast at one end and a turntable at the other. A typical anechoic chamber with a conductive ground plane is shown in figure B.2.

This type of test chamber attempts to simulate an ideal Open Area Test Site whose primary characteristic is a perfectly conducting ground plane of infinite extent.

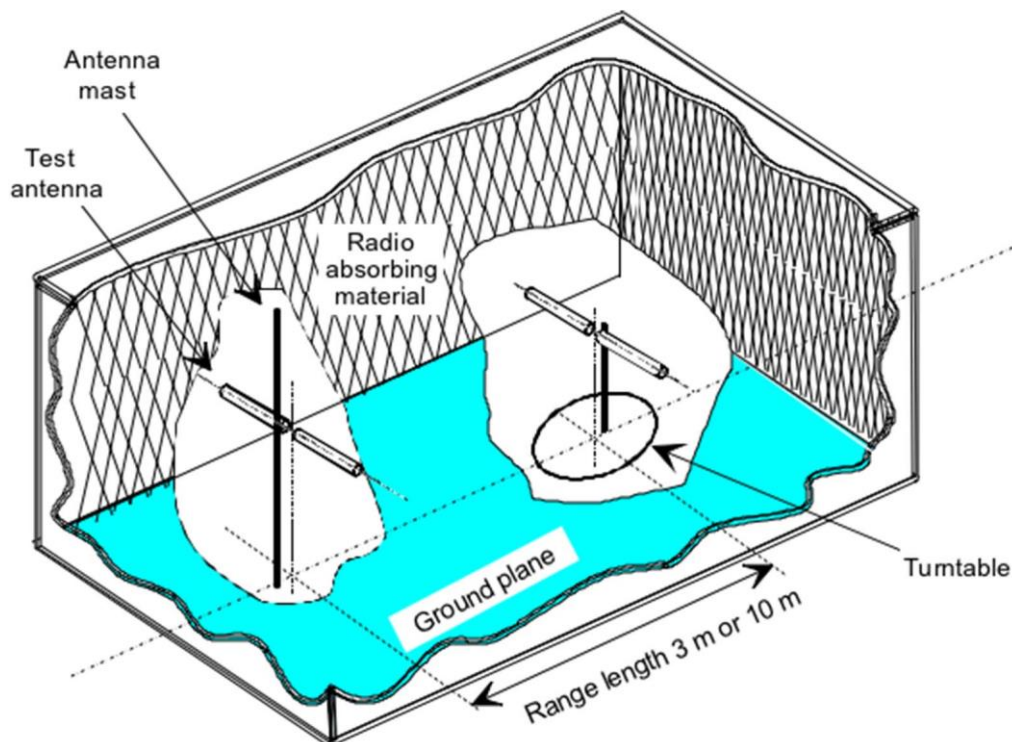

Figure B.2: A typical Anechoic Chamber with a conductive ground plane

In this facility the ground plane creates the wanted reflection path, such that the signal received by the receiving antenna is the sum of the signals from both the direct and reflected transmission paths. This creates a unique received signal level for each height of the transmitting antenna (or EUT) and the receiving antenna above the ground plane.

The antenna mast provides a variable height facility (from 1 m to 4 m) so that the position of the test antenna can be optimized for maximum coupled signal between antennas or between an EUT and the test antenna.

A turntable is capable of rotation through 360 °in the horizontal plane and it is used to support the test sample (EUT) at a specified height, usually 1,5 m above the ground plane. The chamber shall be large enough to allow the measuring distance of at least 3 m or $2(d_1+d_2)^2/\lambda$ (m), whichever is greater (see clause B.2.5). The distance used in actual measurements shall be recorded with the test results.

Emission testing involves firstly "peaking" the field strength from the EUT by raising and lowering the receiving antenna on the mast (to obtain the maximum constructive interference of the direct and reflected signals from the EUT) and then rotating the turntable for a "peak" in the azimuth plane. At this height of the test antenna on the mast, the amplitude of the received signal is noted. Secondly the EUT is replaced by a substitution antenna (positioned at the EUT's phase or volume centre), which is connected to a signal generator. The signal is again "peaked" and the signal generator output adjusted until the level, noted in stage one, is again measured on the receiving device.

Receiver sensitivity tests over a ground plane also involve "peaking" the field strength by raising and lowering the test antenna on the mast to obtain the maximum constructive interference of the direct and reflected signals, this time using a measuring antenna which has been positioned where the phase or volume centre of the EUT will be during testing. A transform factor is derived. The test antenna remains at the same height for stage two, during which the measuring antenna is replaced by the EUT. The amplitude of the transmitted signal is reduced to determine the field strength level at which a specified response is obtained from the EUT.

B.1.4 Open Area Test Site (OATS)

An Open Area Test Site comprises a turntable at one end and an antenna mast of variable height at the other end above a ground plane, which in the ideal case, is perfectly conducting and of infinite extent. In practice, whilst good conductivity can be achieved, the ground plane size has to be limited. A typical Open Area Test Site is shown in figure B.3.

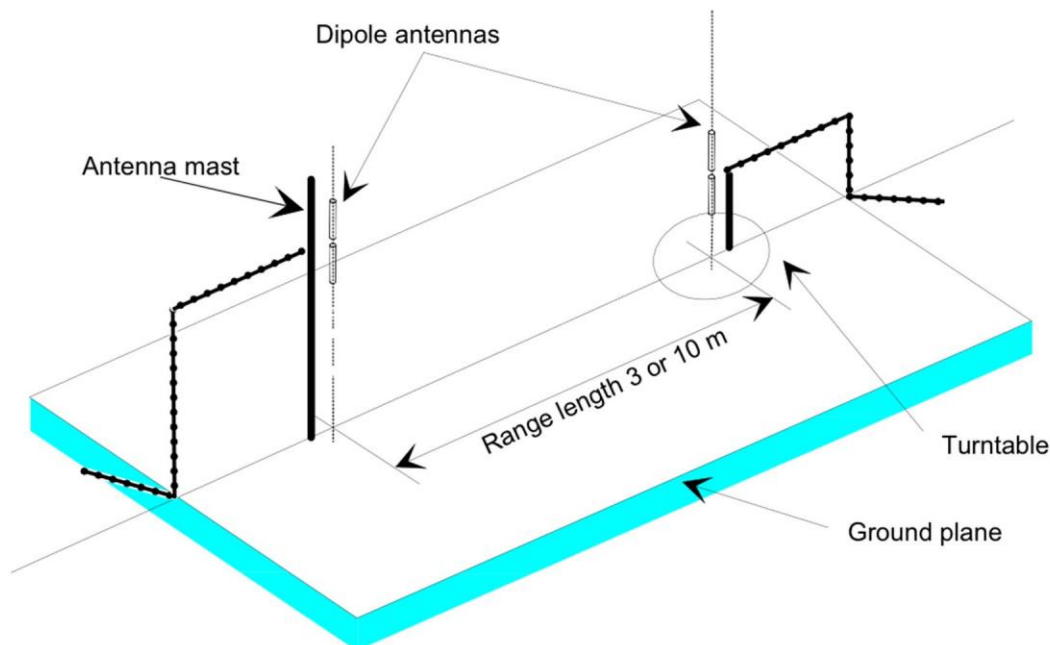

Figure B.3: A typical Open Area Test Site

The ground plane creates a wanted reflection path, such that the signal received by the receiving antenna is the sum of the signals received from the direct and reflected transmission paths. The phasing of these two signals creates a unique received level for each height of the transmitting antenna (or EUT) and the receiving antenna above the ground plane.

Site qualification concerning antenna positions, turntable, measurement distance and other arrangements are same as for anechoic chamber with a ground plane. In radiated measurements an OATS is also used by the same way as anechoic chamber with a ground plane.

Typical measuring arrangement common for ground plane test sites is presented in figure B.4.

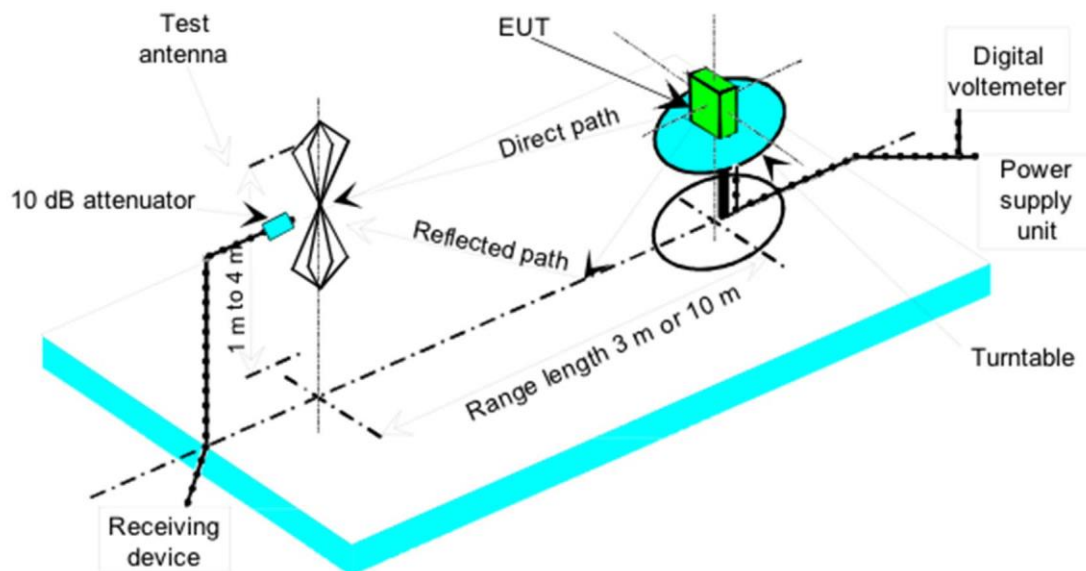

Figure B.4: Measuring arrangement on ground plane test site (OATS set-up for spurious emission testing)

B.1.5 Test antenna

A test antenna is always used in radiated test methods. In emission tests (i.e. frequency error, effective radiated power, spurious emissions and adjacent channel power) the test antenna is used to detect the field from the EUT in one stage of the measurement and from the substitution antenna in the other stage. When the test site is used for the measurement of receiver characteristics (i.e. sensitivity and various immunity parameters) the antenna is used as the transmitting device.

The test antenna should be mounted on a support capable of allowing the antenna to be used in either horizontal or vertical polarization which, on ground plane sites (i.e. anechoic chambers with ground planes and Open Area Test Sites), should additionally allow the height of its centre above the ground to be varied over the specified range (usually 1 m to 4 m).

In the frequency band 30 MHz to 1 000 MHz, dipole antennas which shall be constructed in accordance with ANSI C63.5 [2] are generally recommended. For frequencies of 80 MHz and above, the dipoles should have their arm lengths set for resonance at the frequency of test. Below 80 MHz, shortened arm lengths are recommended. For spurious emission testing, however, a combination of bicones and log periodic dipole array antennas (commonly termed "log periodics") could be used to cover the entire 30 MHz to 1 000 MHz band. Above 1 000 MHz, waveguide horns are recommended although, again, log periodics could be used.

NOTE: The gain of a horn antenna is generally expressed relative to an isotropic radiator.

B.1.6 Substitution antenna

The substitution antenna is used to replace the EUT for tests in which a transmitting parameter (i.e. frequency error, effective radiated power, spurious emissions and adjacent channel power) is being measured. For measurements in the frequency band 30 MHz to 1 000 MHz, the substitution antenna should be a dipole antenna (constructed in accordance with ANSI C63.5 [2]). For frequencies of 80 MHz and above, the dipoles should have their arm lengths set for resonance at the frequency of test. Below 80 MHz, shortened arm lengths are recommended. For measurements above 1 000 MHz, a waveguide horn is recommended. The centre of this antenna should coincide with either the phase centre or volume centre.

B.1.7 Measuring antenna

The measuring antenna is used in tests on an EUT in which a receiving parameter (i.e. sensitivity and various immunity tests) is being measured. Its purpose is to enable a measurement of the electric field strength in the vicinity of the EUT.

For measurements in the frequency band 30 MHz to 1 000 MHz, the measuring antenna should be a dipole antenna (constructed in accordance with ANSI C63.5 [2]). For frequencies of 80 MHz and above, the dipoles should have their arm lengths set for resonance at the frequency of test. Below 80 MHz, shortened arm lengths are recommended. The centre of this antenna should coincide with either the phase centre or volume centre (as specified in the test method) of the EUT.

B.1.8 Stripline arrangement

B.1.8.1 General

The stripline arrangement is a RF coupling device for coupling the integral antenna of an equipment to a 50 Ω radio frequency terminal. This allows the radiated measurements to be performed without an open air test site but in a restricted frequency range. Absolute or relative measurements can be performed; absolute measurements require a calibration of the stripline arrangement.

B.1.8.2 Description

The stripline is made of three highly conductive sheets forming part of a transmission line, which allows the equipment under test to be placed within a known electric field. They shall be sufficiently rigid to support the equipment under test.

Two examples of stripline characteristics are given in table B.1.

Table B.1

		IEC 60489-3 App. J [i.4]	MPT 1314 [i.11], clause 3.10.4
Useful frequency range	MHz	1 to 200	0,1 to 4 000
Equipment size limits (antenna included)	Length	200 mm	1 200 mm
	Width	200 mm	1 200 mm
	Height	250 mm	400 mm

B.1.8.3 Calibration

The aim of calibration is to establish at any frequency a relationship between the voltage applied by the signal generator and the field strength at the designated test area inside the stripline.

B.1.8.4 Mode of use

The stripline arrangement may be used for all radiated measurements within its calibrated frequency range.

The method of measurement is the same as the method using an open air test site with the following change. The stripline arrangement input socket is used instead of the test antenna.

B.2 Guidance on the use of radiation test sites

B.2.1 General

This clause details procedures, test equipment arrangements and verification that should be carried out before any of the radiated tests are undertaken. These schemes are common to all types of test sites described in annex B.

B.2.2 Verification of the test site

No test shall be carried out on a test site which does not possess a valid certificate of verification. The verification procedures for the different types of test sites described in annex B (i.e. anechoic chamber, anechoic chamber with a ground plane and Open Area Test Site) are given in ETSI TR 102 273 [1].

B.2.3 Preparation of the EUT

The provider should supply information about the EUT covering the operating frequency, polarization, supply voltage(s) and the reference face. Additional information, specific to the type of EUT should include, where relevant, carrier power, channel separation, whether different operating modes are available (e.g. high and low power modes) and if operation is continuous or is subject to a maximum test duty cycle (e.g. 1 minute on, 4 minutes off).

Where necessary, a mounting bracket of minimal size should be available for mounting the EUT on the turntable. This bracket should be made from low conductivity, low relative dielectric constant (i.e. less than 1,5) material(s) such as expanded polystyrene, balsa wood, etc.

B.2.4 Power supplies to the EUT

All tests should be performed using power supplies wherever possible, including tests on EUT designed for battery-only use. In all cases, power leads should be connected to the EUT's supply terminals (and monitored with a digital voltmeter) but the battery should remain present, electrically isolated from the rest of the equipment, possibly by putting tape over its contacts.

The presence of these power cables can, however, affect the measured performance of the EUT. For this reason, they should be made to be "transparent" as far as the testing is concerned. This can be achieved by routing them away from the EUT and down to the either the screen, ground plane or facility wall (as appropriate) by the shortest possible paths. Precautions should be taken to minimize pick-up on these leads (e.g. the leads could be twisted together, loaded with ferrite beads at 0,15 metres spacing or otherwise loaded).

B.2.5 Range length

The range length for all these types of test facility for testing in the far-field of the EUT i.e. it should be equal to or exceed:

$$\frac{2(d_1 + d_2)^2}{\lambda}$$

where:

d_1 is the largest dimension of the EUT/dipole after substitution (m);

d_2 is the largest dimension of the test antenna (m);

λ is the test frequency wavelength (m).

It should be noted that in the substitution part of this measurement, where both test and substitution antennas are half wavelength dipoles, this minimum range length for far-field testing would be: 2λ

It should be noted in the test report when either of these conditions is not met so that the additional measurement uncertainty can be incorporated into the results.

NOTE 1: **For the fully anechoic chamber**, no part of the volume of the EUT should, at any angle of rotation of the turntable, fall outside the "quiet zone" of the chamber at the nominal frequency of the test.

NOTE 2: The "quiet zone" is a volume within the anechoic chamber (without a ground plane) in which a specified performance has either been proven by test, or is guaranteed by the designer/manufacture. The specified performance is usually the reflectivity of the absorbing panels or a directly related parameter (e.g. signal uniformity in amplitude and phase). It should be noted however that the defining levels of the quiet zone tend to vary.

NOTE 3: **For the anechoic chamber with a ground plane**, a full height scanning capability, i.e. 1 m to 4 m, should be available for which no part of the test antenna should come within 1 m of the absorbing panels. For both types of Anechoic Chamber, the reflectivity of the absorbing panels should not be worse than -5 dB.

NOTE 4: **For both the anechoic chamber with a ground plane and the Open Area Test Site**, no part of any antenna should come within 0,25 m of the ground plane at any time throughout the tests. Where any of these conditions cannot be met, measurements should not be carried out.

B.2.6 Site preparation

The cables for both ends of the test site should be routed horizontally away from the testing area for a minimum of 2 m (unless, in the case both types of anechoic chamber, a back wall is reached) and then allowed to drop vertically and out through either the ground plane or screen (as appropriate) to the test equipment. Precautions should be taken to minimize pick up on these leads (e.g. dressing with ferrite beads, or other loading). The cables, their routing and dressing should be identical to the verification set-up.

NOTE: For ground reflection test sites (i.e. anechoic chambers with ground planes and Open Area Test Sites), which incorporate a cable drum with the antenna mast, the 2 m requirement may be impossible to comply with.

Calibration data for all items of test equipment should be available and valid. For test, substitution and measuring antennas, the data should include gain relative to an isotropic radiator (or antenna factor) for the frequency of test. Also, the VSWR of the substitution and measuring antennas should be known.

The calibration data on all cables and attenuators should include insertion loss and VSWR throughout the entire frequency range of the tests. All VSWR and insertion loss figures should be recorded in the log book results sheet for the specific test.

Where correction factors/tables are required, these should be immediately available.

For all items of test equipment, the maximum errors they exhibit should be known along with the distribution of the error e.g.:

- cable loss: $\pm 0,5$ dB with a rectangular distribution;
- measuring receiver: 1,0 dB (standard deviation) signal level accuracy with a Gaussian error distribution.

At the start of measurements, system checks should be made on the items of test equipment used on the test site.

B.3 Coupling of signals

B.3.1 General

The presence of leads in the radiated field may cause a disturbance of that field and lead to additional measurement uncertainty. These disturbances can be minimized by using suitable coupling methods, offering signal isolation and minimum field disturbance (e.g. optical and acoustic coupling).

B.3.2 Data signals

Isolation can be provided by the use of optical, ultrasonic or infrared means. Field disturbance can be minimized by using a suitable fibre optic connection. Ultra sonic or infrared radiated connections require suitable measures for the minimization of ambient noise.

B.4 Standard test position

The standard position in all test sites, except the stripline arrangement, for equipment which is not intended to be worn on a person, including hand-held equipment, shall be on a non conducting support, height 1,5 m, capable of rotating about a vertical axis through the equipment. The standard position of the equipment shall be the following:

- a) for equipment with an internal antenna, it shall be placed in the position closest to normal use as declared by the provider;
- b) for equipment with a rigid external antenna, the antenna shall be vertical;
- c) for equipment with a non-rigid external antenna, the antenna shall be extended vertically upwards by a non-conducting support.

Equipment which is intended to be worn on a person may be tested using a simulated man as support. The simulated man comprises a rotatable acrylic tube filled with salt water, placed on the ground.

The container shall have the following dimensions:

- Height: 1,7 m \pm 0,1 m;
Inside diameter: 300 mm \pm 5 mm;
Sidewall thickness: 5 mm \pm 0,5 mm.

The container shall be filled with a salt (NaCl) solution of 1,5 g per litre of distilled water.

The equipment shall be fixed to the surface of the simulated man, at the appropriate height for the equipment.

NOTE: To reduce the weight of the simulated man it may be possible to use an alternative tube which has a hollow centre of 220 mm maximum diameter.

In the stripline arrangement the equipment under test or the substitution antenna is placed in the designated test area in the normal operational position, relative to the applied field, on a pedestal made of a low dielectric material (dielectric constant less than 2).

B.5 Test fixture

B.5.1 General

The test fixture is only needed for the assessment of integral antenna equipment.

B.5.2 Description

The test fixture is a radio frequency coupling device associated with an integral antenna equipment for coupling the integral antenna to a 50 Ω radio frequency terminal at the working frequencies of the equipment under test. This allows certain measurements to be performed using the conducted measurement methods. Only relative measurements may be performed and only those at or near frequencies for which the test fixture has been calibrated.

In addition, the test fixture may provide:

- a connection to an external power supply;
- in the case of assessment of speech equipment, an audio interface either by direct connection or by an acoustic coupler.

In the case of non-speech equipment, the test fixture can also provide the suitable coupling means e.g. for the data output.

The test fixture shall normally be provided by the provider.

The performance characteristics of the test fixture shall be approved by the testing laboratory and shall conform to the following basic parameters:

- a) the coupling loss shall not be greater than 30 dB;
- b) a coupling loss variation over the frequency range used in the measurement which does not exceed 2 dB;
- c) circuitry associated with the RF coupling shall contain no active or non-linear devices;
- d) the VSWR at the 50 Ω socket shall not be more than 1,5 over the frequency range of the measurements;
- e) the coupling loss shall be independent of the position of the test fixture and be unaffected by the proximity of surrounding objects or people. The coupling loss shall be reproducible when the equipment under test is removed and replaced;
- f) the coupling loss shall remain substantially constant when the environmental conditions are varied.

The characteristics and calibration shall be included in the test report.

B.5.3 Calibration

The calibration of the test fixture establishes a relationship between the output of the signal generator and the field strength applied to the equipment placed in the test fixture.

The calibration is valid only at a given frequency and for a given polarization of the reference field.

The actual set-up used depends on the type of the equipment (e.g. data, speech, etc.).

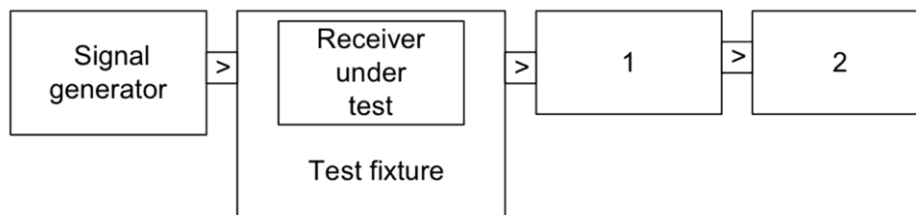

- 1) Coupling device.
- 2) Device for assessing the performance, e.g. distortion factor, BER measuring device, etc.

Figure B.5: Measuring arrangement for calibration

Method of calibration:

- Measure the sensitivity expressed as a field strength, as specified in the present document and note the value of this field strength in dB μ V/m and the polarization used.
- Place the receiver in the test fixture, which is connected to the signal generator. The level of the signal generator producing:
 - a bit error ratio of 0,01; or
 - a message acceptance ratio of 80 %, as appropriate;
 shall be noted.

The calibration of the test fixture is the relationship between the field strength in dB μ V/m and the signal generator level in dB μ V emf. This relationship is expected to be linear.

B.5.4 Mode of use

The test fixture may be used to facilitate some of the measurements in the case of equipment having an integral antenna.

It is used in particular for the measurement of the radiated carrier power and usable sensitivity expressed as a field strength under extreme test conditions.

For the transmitter measurements calibration is not required as relative measuring methods are used.

For the receiver measurements calibration is necessary in order to determine absolute measurement levels.

To apply the specified wanted signal level expressed in field strength, convert it into the signal generator level (emf) using the calibration of the test fixture. Apply this value to the signal generator.

Annex C (normative): Mitigation technique

C.1 Introduction

For all interoperable railway lines (international rail traffic) R-GSM systems will operate the BCCH in the band 921 MHz to 925 MHz. However at non-interoperable railway lines (such as shunting yards) ER-GSM might be used, which operates within the band 918 MHz to 921 MHz. In order for RFID to share the band 918 MHz to 921 MHz with ER-GSM band, all RFID systems shall use an acceptable mitigation technique.

This annex describes two alternative mitigation techniques. Both techniques rely on monitoring the environment at the RFID system and taking appropriate action in the event that a potential victim is detected within the immediate vicinity. The first technique is based on the approach described in clause 6.3 of ETSI TS 102 902 (V1.2.1) [i.7] and is dependent on the availability of ER-GSM receivers. Details of the second technique are described in clause C.4 below.

C.2 Principle of operation

Both mitigation techniques are based on the detection and decoding of the Broadcast Channel (BCCH) from a GSM-R base station. In order to provide acceptable sharing between ER-GSM and RFID, interrogators shall scan either all or part of the GSM-R band (918 MHz to 925 MHz) for carriers containing a BCCH message. The information in the BCCH message will provide details of any channel allocations in the ER-GSM band and details of any neighbouring base stations also operating in this band.

The process of scanning for carriers with BCCH or TCH channels will take place on start-up of interrogators at a site prior to any RFID communication. Thereafter, assuming the interrogators are switched on continuously, scanning for BCCH and TCH carriers will be repeated at least once every 24 hours.

C.3 Method 1 - Scanning band 918 MHz to 925 MHz

The ER-GSM receiver(s) shall scan the downlink band (918 MHz - 925 MHz) for the presence of channels transmitting BCCH signals. The ER-GSM receiver(s) shall receive and decode every BCCH transmission identified in the downlink band. The message of relevance within the Broadcast Channel of the BCCH is the SYSTEM INFORMATION TYPE 1 (see clause 9.1.31 of ETSI TS 144 018 [3]) message containing the Cell Channel Description IE.

From the received information corresponding to the BCCH Cell Channel Description IE, the RFID interrogator(s) shall create a list of all ARFCN used by ER-GSM in the local area of its operation. This list shall be used to determine whether high power RFID channels are available in the ER-GSM band using the logic presented in figure C.1.

C.4 Method 2 - Scanning band 921 MHz to 925 MHz

This method shall only be used in situations where ER-GSM receivers are unavailable. The R-GSM receiver(s) shall scan the R-GSM downlink band (921 MHz to 925 MHz) for the presence of channels transmitting BCCH signals. The R-GSM receiver(s) shall receive and decode every BCCH transmission identified in the downlink band. The message of relevance within the Broadcast Channel of the BCCH is the SYSTEM INFORMATION TYPE 1 (see clause 9.1.31 of ETSI TS 144 018 [3]) message containing the Cell Channel Description IE.

From the received information corresponding to the BCCH Cell Channel Description IE, the RFID interrogator(s) shall create a list of all ARFCN used by ER-GSM in the local area of its operation. This list shall be used to determine whether high power RFID channels are available in the ER-GSM band using the principles in figure C.1.

In addition the R-GSM receiver shall decode the BCCH message for details of any channels allocated to other base stations operating in the ER-GSM band that are in the same geographic area. Where the information shows the presence of a BTS in the ER-GSM band, interrogators shall cease all transmission on both designated high powered channels in the sub-band 918 MHz to 921 MHz. This will ensure protection for all railway communication systems operating in the ER-GSM band.

C.5 Technical requirements

The detection threshold of the BCCH information by GSM-R receivers shall be possible down to -98 dBm at the centre frequency of each of the ER-GSM or R-GSM channels. This is the minimum power level specified for non-high-speed railways tracks (see EIRENE [i.8]).

An interrogator shall not use any of the RFID TX channels with a centre frequency of less than 700 kHz from any channel stored in the ARFCN list, if the received power level from the BTS is more than or equal to -98 dBm.

C.6 Requirements for Method 1

When using the mitigation technique specified in clause C.3, the flow diagram, shown in figure C.1 shall be used. This determines whether channels are available to interrogators when allocations for ER-GSM channels have been detected.

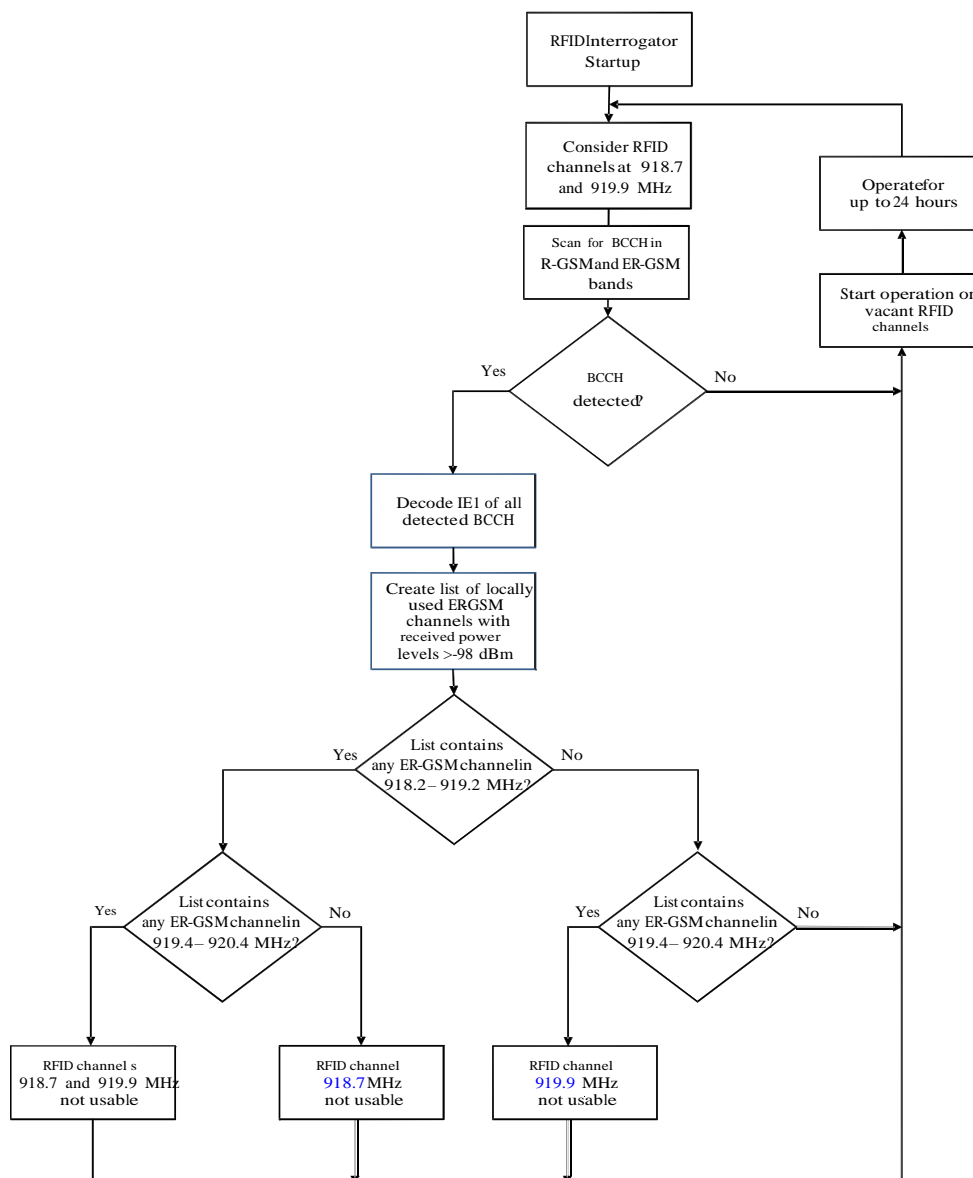

Figure C.1: GSM-R Downlink detection for ER-GSM band and RFID DAA process

Figure C.2 below shows those ER-GSM channels that prevent the operation of RFID interrogators in the relevant high power channels. For example an ER-GSM TCH channel operating at a centre frequency of 918,2 MHz would prevent operation of an interrogator at a centre frequency of 918,7 MHz.

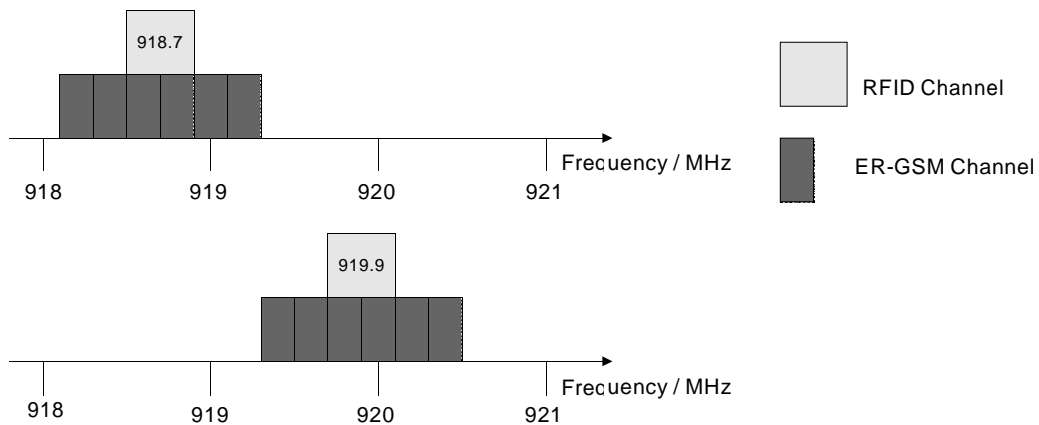

Figure C.2: Illustration of interference between ER-GSM and RFID channels

C.7 Requirements for Method 2

When using the mitigation technique in clause C.4, a R-GSM receiver shall decode all BCCH messages in the band 921 MHz to 925 MHz. In the event that the R-GSM receiver detects that an ER-GSM channel has been allocated within 700 kHz of an RFID interrogator channel, the interrogator shall prevent transmission of the relevant high power channel. This shall be achieved using the principles shown in figure C.1.

In addition if any decoded message shows the presence of a BTS in the band 918 MHz to 921 MHz, all interrogators connected to that R-GSM receiver shall automatically cease to transmit. Transmission by these interrogators shall not resume until the R-GSM receiver is no longer able to detect the presence of a BTS in the band 918 MHz to 921 MHz.

Testing to ensure compliance of RFID systems to either Method 1 or Method 2 shall be performed in accordance with the tests specified in clause 5.5.8.

Annex D (informative): Bibliography

- IEC Publication 489-3 Second edition (1988), Appendix F pages 130 to 133.
- Ketterling, H-P: "Verification of the performance of fully and semi-anechoic chambers for radiation measurements and susceptibility/immunity testing", 1991, Leatherhead/Surrey.
- Directive 2004/108/EC of the European Parliament and of the Council of 15 December on the approximation of the laws of the Member States relating to electromagnetic compatibility and replacing Directive 89/336/EC.
- CEPT/ERC Recommendation 01-06: "Procedure for mutual recognition of type testing and type approval for radio equipment".
- Recommendation ITU-R BS.559-2: "Objective measurement of radio-frequency protection ratios in LF, MF and HF broadcasting".
- ETSI TR 100 027: "ElectroMagnetic Compatibility and Radio Spectrum Matters (ERM); Methods of measurement for private mobile radio equipment".
- ETSI EN 300 220 (all parts): "Electromagnetic compatibility and Radio spectrum Matters (ERM); Short Range Devices (SRD); Radio equipment to be used in the 25 MHz to 1 000 MHz frequency range with power levels ranging up to 500 mW".
- Directive 98/34/EC of the European Parliament and of the Council of 22 June 1998 laying down a procedure for the provision of information in the field of technical standards and regulations.
- ETSI EN 301 489-1: "Electromagnetic compatibility and Radio spectrum Matters (ERM); ElectroMagnetic Compatibility (EMC) standard for radio equipment and services; Part 1: Common technical requirements".
- ETSI EN 301 489-3: "Electromagnetic compatibility and Radio spectrum Matters (ERM); ElectroMagnetic Compatibility (EMC) standard for radio equipment and services; Part 3: Specific conditions for Short-Range Devices (SRD) operating on frequencies between 9 kHz and 246 GHz".

History

Document history		
V1.1.1	September 2004	Publication as ETSI EN 302 208 part 1 and part 2
V1.1.2	July 2006	Publication as ETSI EN 302 208-1
V1.2.1	April 2008	Publication as ETSI EN 302 208 part 1 and part 2
V1.3.1	February 2010	Publication as ETSI EN 302 208 part 1 and part 2
V1.4.1	November 2011	Publication as ETSI EN 302 208 part 1 and part 2
V2.1.1	February 2015	Publication as ETSI EN 302 208 part 1 and part 2
V3.1.0	February 2016	EN Approval Procedure AP 20160522: 2016-02-22 to 2016-05-23
V3.1.1	November 2016	Publication